



US00D458318S

(12) **United States Design Patent** (10) **Patent No.:** **US D458,318 S**
Christianson (45) **Date of Patent:** **** Jun. 4, 2002**

(54) **ROBOT**
(75) Inventor: **Tristan M. Christianson**, San Francisco, CA (US)
(73) Assignee: **Sharper Image Corporation**, San Francisco, CA (US)
(**) Term: **14 Years**
(21) Appl. No.: **29/130,892**
(22) Filed: **Oct. 10, 2000**
(51) **LOC (7) Cl.** **21-01**
(52) **U.S. Cl.** **D21/578**
(58) **Field of Search** D21/578-583, D21/593, 594, 621, 622; 446/268, 271, 272, 279, 280, 289-292, 297-303, 354, 355; D15/199

(56) **References Cited**
U.S. PATENT DOCUMENTS
D251,628 S * 4/1979 McQuarrie et al. D21/578
D258,900 S * 4/1981 Lanusse D21/578
D262,643 S * 1/1982 Wong D21/578
D287,986 S * 1/1987 Matsui D21/578
4,654,659 A * 3/1987 Kubo 446/271
D293,344 S * 12/1987 Shiraishi D21/578
4,717,365 A * 1/1988 Furukawa 446/280
D297,749 S * 9/1988 Rodis-jamero D21/578
D437,368 S * 2/2001 Tsai D21/578

OTHER PUBLICATIONS
Robotix Robot Commander, Assembly Guide 98600, Copyright 1997 Learning Curve International, LLC, Chicago, IL 60610, 35 pages.
Robot 2001, The Sharper Image Gift Catalogue, May 1998, 1 page.
Danger! Danger! No longer are they Lost in Space, but . . . Robots Get Real, by Charles Gallardo Tech/Biz, Marin Independent Journal, Monday, May 11, 1998; 3 pages.
Sony pushes robot spec—Sony defines an open architecture for the ‘entertainment robot’; by Yoshiko Hara, Tokyo, Electronic Engineering Times, Jun. 15, 1998; 3 pages.

Ripjaw, ©1999 Toymax Inc., Plainview, NY 11803, 4 pages.
Robo-Puppy, Sony’s R&D lab releases Aibo, a robotic, programmable puppy, and offers a glimpse of next-generation toys, by Carol Levin, PC Magazine On-Line, Internet; May 11, 1999, 2 pages.
Kismet: A robot for social interactions with humans; contact: Cynthia Breazeal, Kismet’s Web Page, <http://www.ai.mit.edu/projects/kismet/kismet.html>, Internet; Oct. 1, 1999; 12 pages.
Aibo, Copyright 1995–1999 Sony Marketing (Japan) Inc. & Sony Corporation; <http://www.world.sony.com/aibo/aibo/about00.html>; Internet; Oct. 28, 1999; 11 pages.

(List continued on next page.)

Primary Examiner—Lucy Lieberman
(74) *Attorney, Agent, or Firm*—Fliesler Dubb Meyer & Lovejoy LLP

(57) **CLAIM**
The ornamental design for a robot, as shown and described.

DESCRIPTION
FIG. 1 is a front perspective view thereof with the left arm in a raised position and both hands in an opened position; FIG. 2 is a rear perspective view thereof with the left arm in a raised position and both hands in an opened position; FIG. 3 is a left side view thereof with the left arm in a raised position and both hands in an opened position; FIG. 4 is a right side view thereof with the left arm in a raised position and both hands in an opened position; FIG. 5 is a front view thereof with the left arm in a raised position and both hands in an opened position; FIG. 6 is a rear view thereof with the left arm in a raised position and both hands in an opened position; FIG. 7 is a top view thereof with the left arm in a raised position and both hands in an opened position; and, FIG. 8 is a bottom view thereof with the left arm in a raised position and both hands in an opened position. The broken lines shown in FIG. 8 are for illustrative purposes only and do not form part of the claimed design.

1 Claim, 8 Drawing Sheets

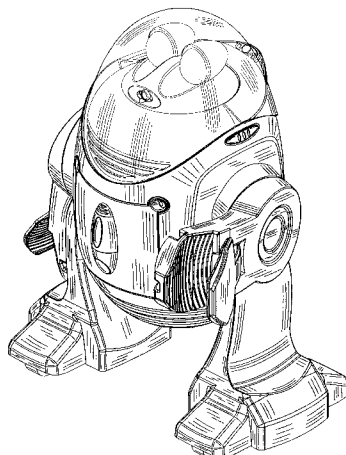

OTHER PUBLICATIONS

Robomotion, by Richard Polito, Tech//Life, Marin Independent Jounsel, Saturday, Dec. 18, 1999; 3 pages.

PC57XP Color Pinhole Microvideo Camera, ©1998 Super-circuits, <http://208.21.248.173/servlet/cat/productPC57XP.htm>; Internet; Dec. 28, 1999; 2 pages.

GP Toys, Emiglio the Robot; Best 100 Toy Winner, 1999, <http://www.drtoy.com/drtoy/99best/gp.htm>; Internet; copyright 1995–2000 Stevanne Auerbach, Ph.D., San Francisco, CA; 1 page.

Congratulations, it's a bot!; by Erik Dank, Wired, Sep. 2000, 4 pages.

Sony Shows Humanoid Robot, by Yuri Kageyama, Technology News, Yahoo! News; Nov. 21, 2000, 3 pages.

Roboxing Fighters, The Sharper Image Gift Catalogue, Dec. 2000, 1 page.

Clinch Radio Control Robot by Nikko, <http://www.amazon.com/exec/obidos/asin/b00004tcdu>; Internet; Jan. 8, 2001; 4 pages.

Robby the Robot; Roboxing Fighters; Vox Centurion; Sony AIBO ERS—210 Robot; QuickDraw Zappin' Wee.Bot; products from The Sharper Image website—<http://sharper-image.com>; Jan. 8, 2001; 2 pages.

Star Wars Episode I Basic Figure Collection II: R2-D2 #7 by Hasbro, http://www.amazon.com/exec/obidos/ASIN2/B00000J2B3/o/qid=979679202/sr=8-1/ref=aps_sr_t_1_1/107-555040-9516524; Internet; Jan. 16, 2001; 3 pages.

R.A.D. Robot 2.0 R/C; Toymax Inc., Plainview, NY 11803, 3 pages.

Aibo Sony's New Entertainment Robot; New Product Update, Robot Science & Technology, pp. 30, 31, 51.

* cited by examiner

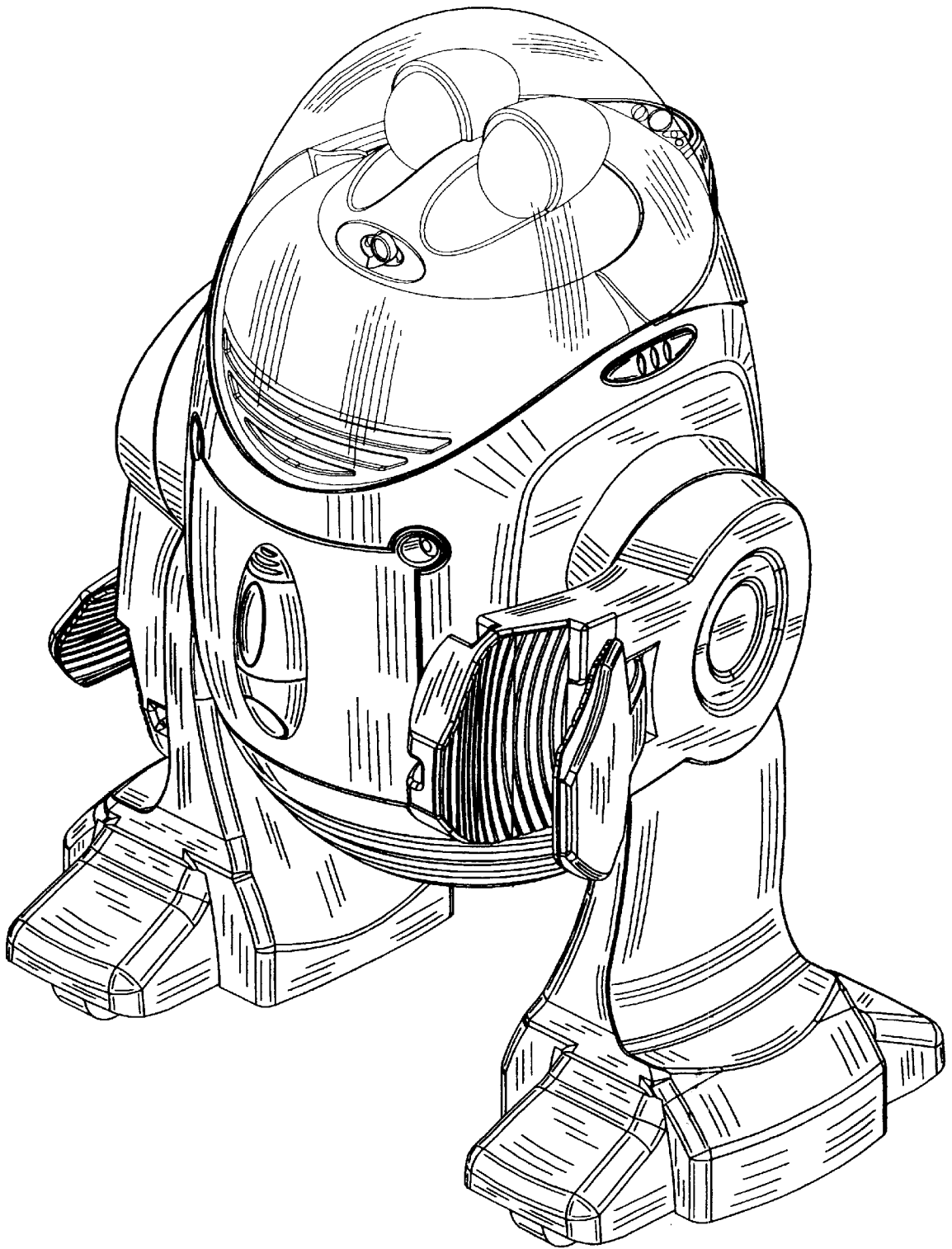

FIG. 1

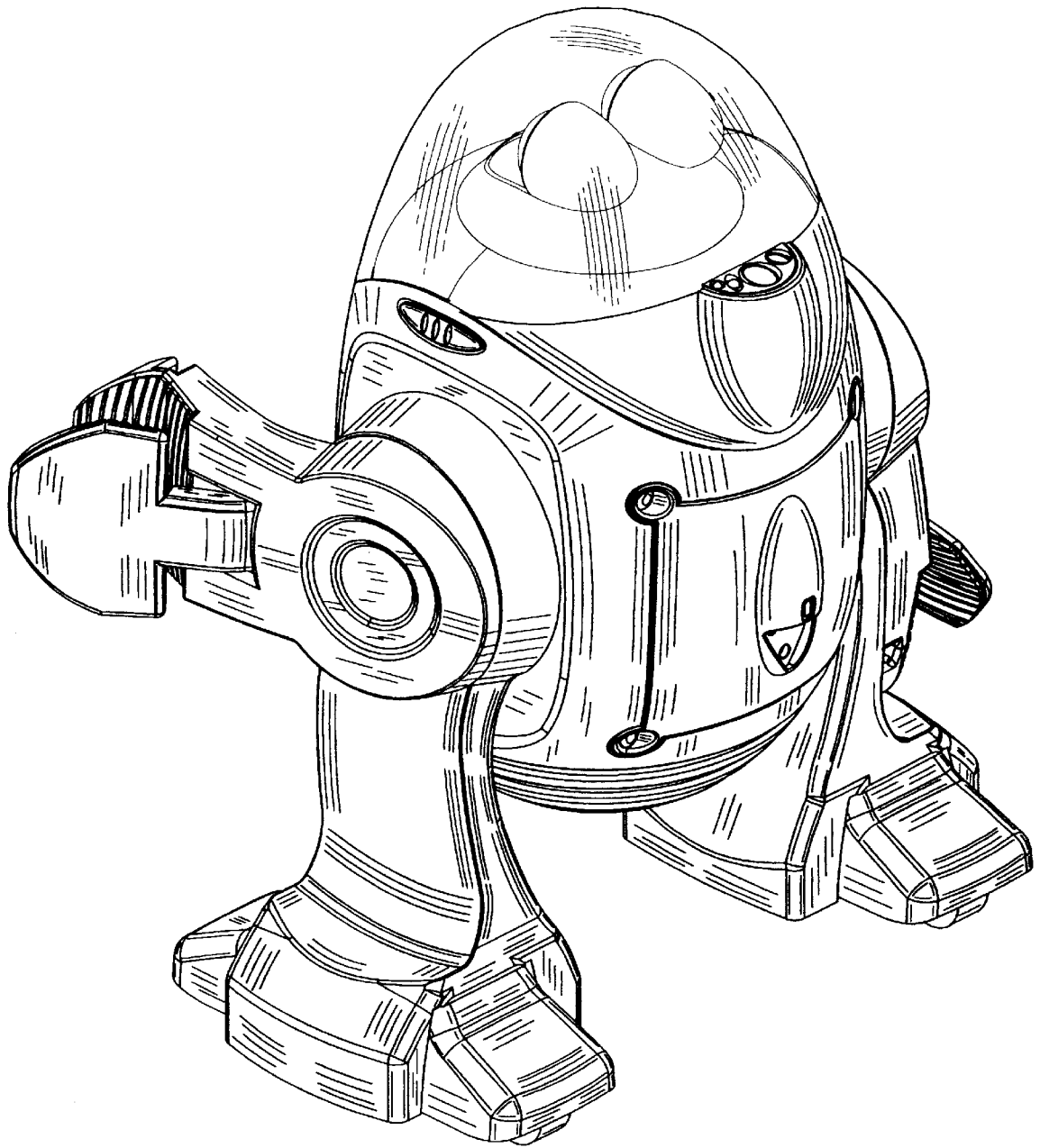

FIG. 2

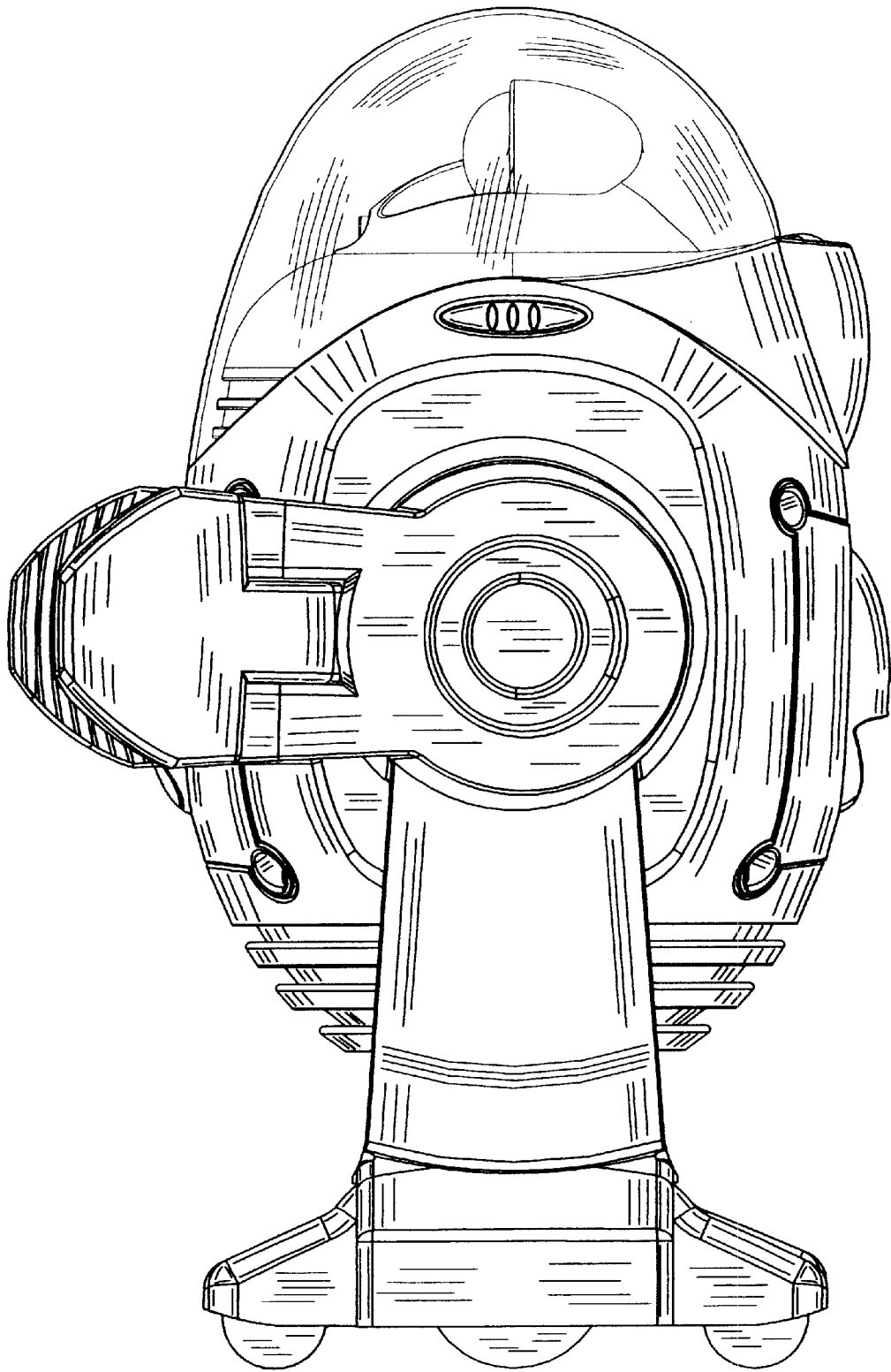

FIG. 3

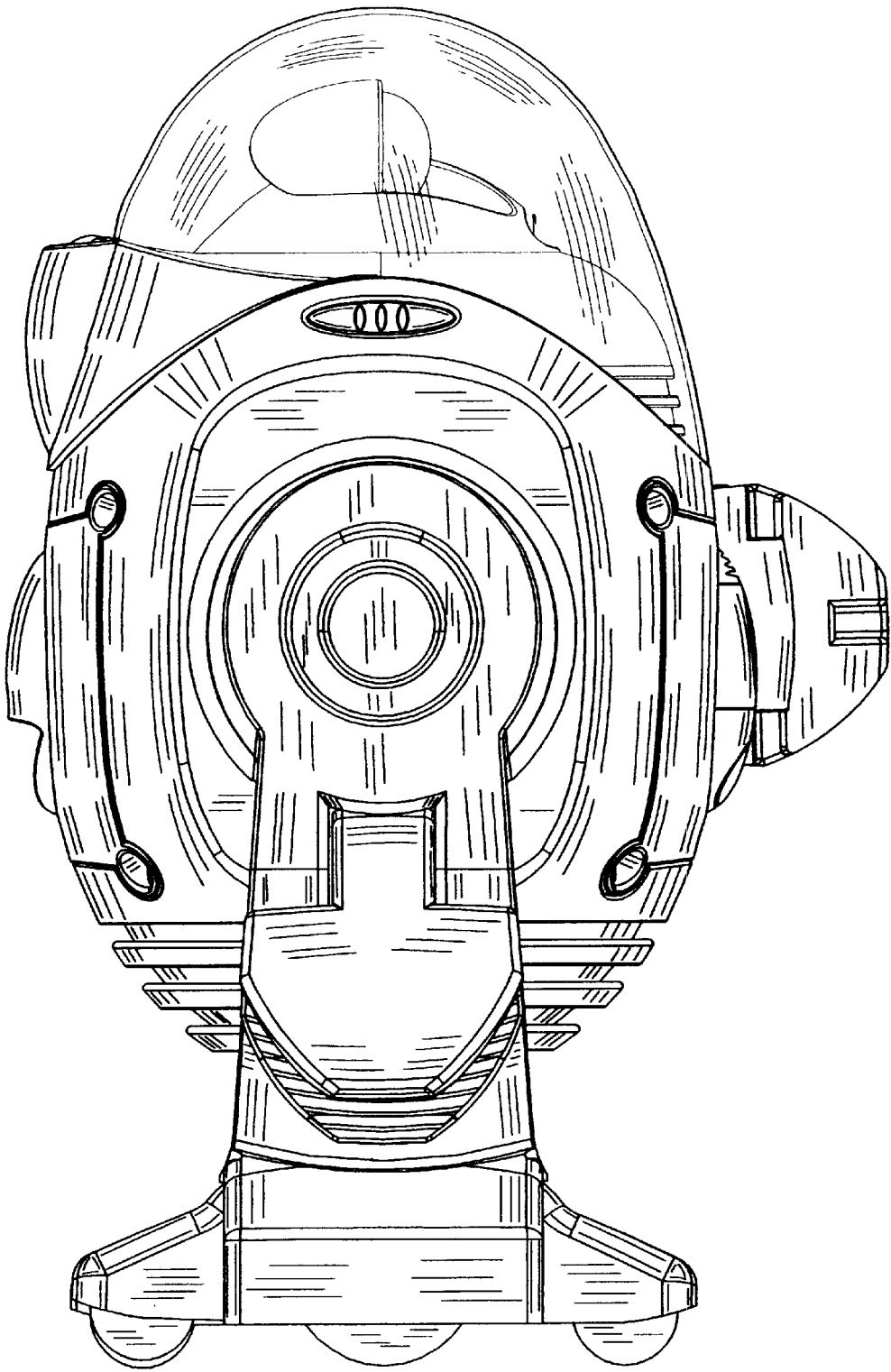

FIG. 4

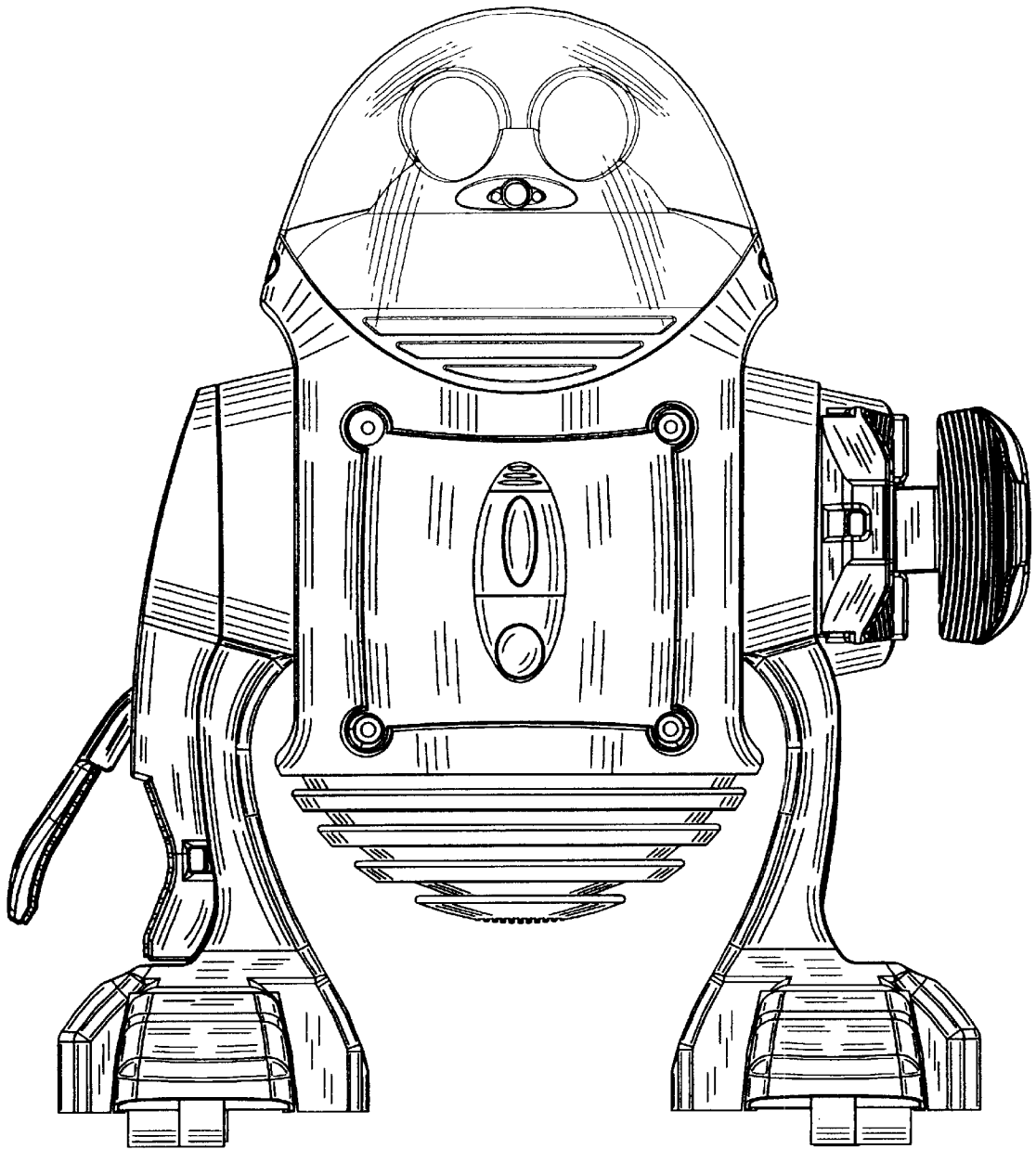

FIG. 5

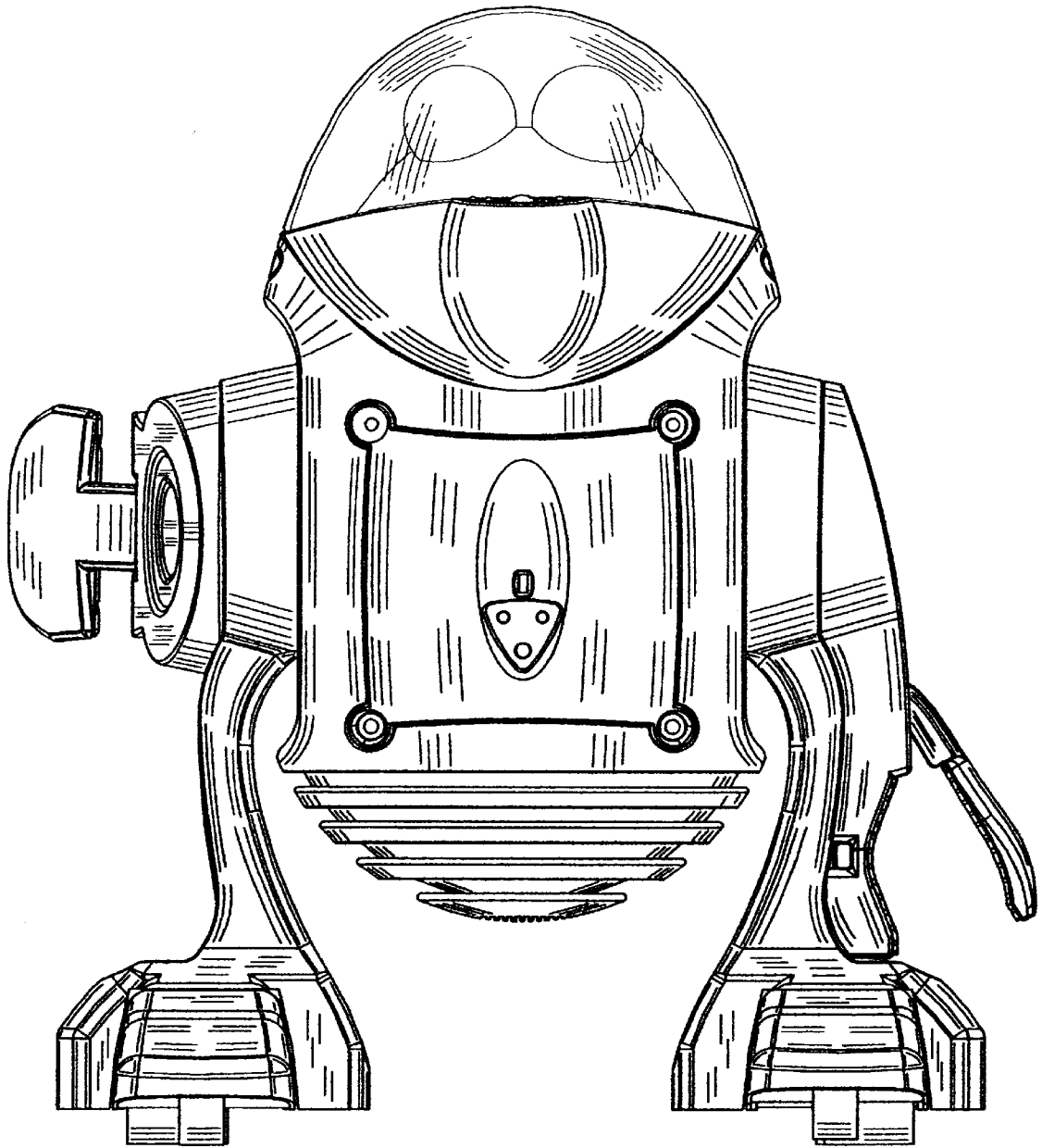

FIG. 6

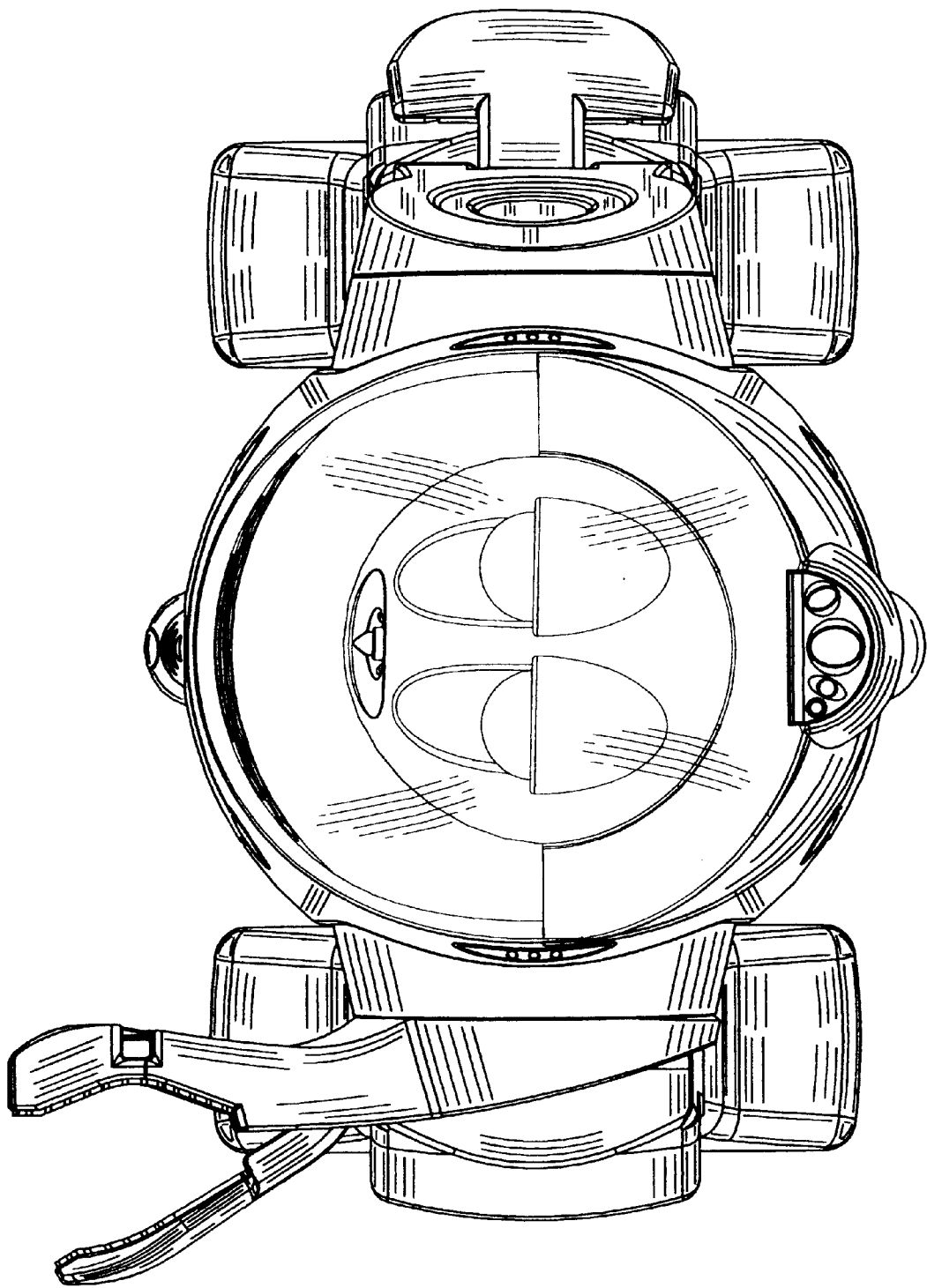

FIG. 7

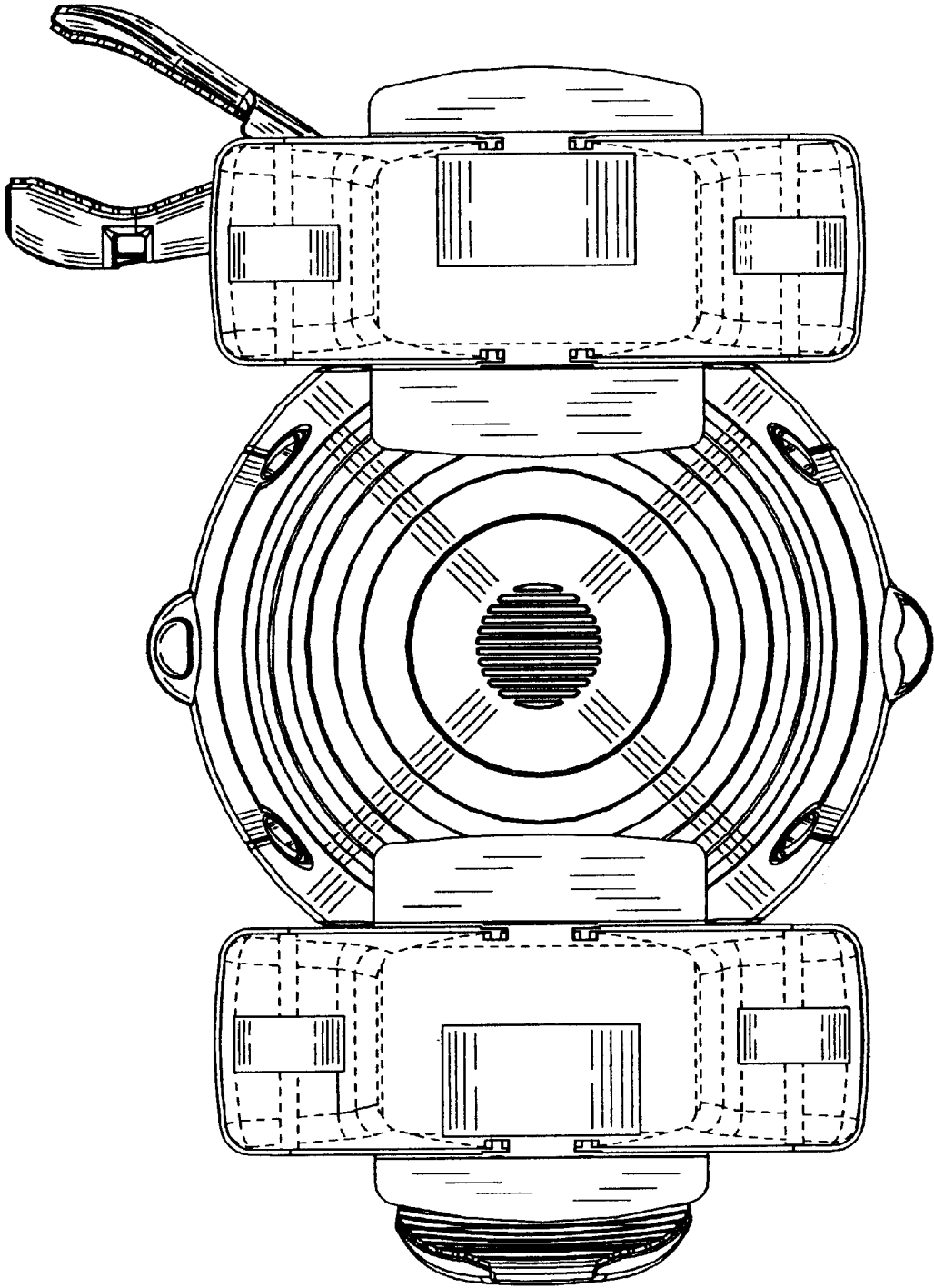

FIG. 8