

Omnibot

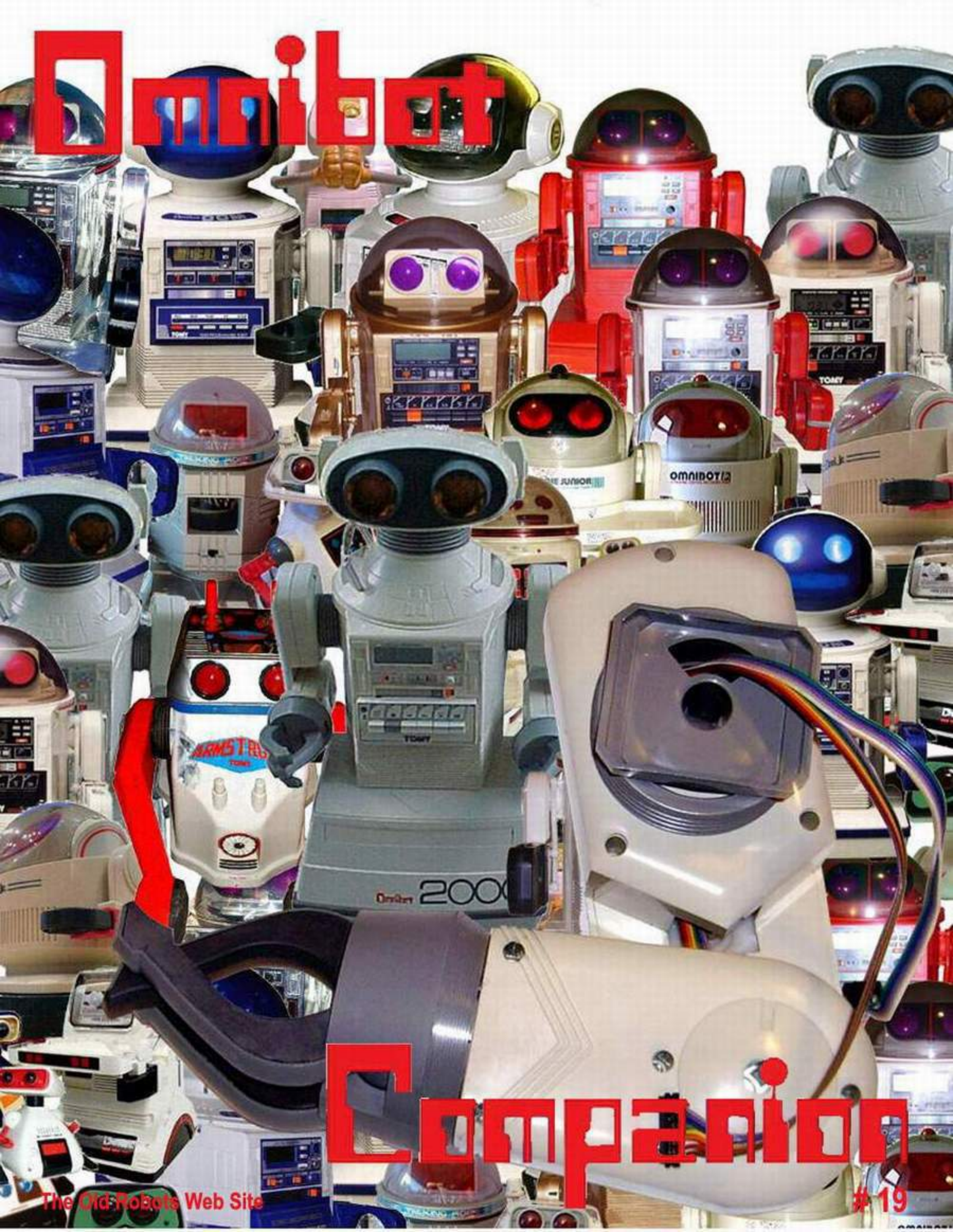

COMPANION

The Old Robots Web Site

Omnibot®2000 - Arm Circuit Board

Robot Companion is a fun, easy-to-understand, hands-on guide that will have you using your own robots in no time. The robots in this book include the "Omnibot Robot," the "Tomy Robots," and even a robot that carries a child on wheels!

You will learn how to find your robot, how to identify a robot by country through frequency allocation, where to buy parts, how to program your robot to perform tasks, and more. This book's companion website includes software program files, parts lists, and links to online parts suppliers.

The robot companion contains a devise set of information and pictures of the robot to familiarize a person with that robot. This approach is used because so little information on the robots from the 1980's exists today, and it will be helpful with the information instructions or manual.

They dance, tell jokes, and even clean your carpet! From the tiniest robot to gigantic factory machines, robotics is all around you. This technology isn't just for science fiction anymore; it's real and more relevant than ever. With stunning visuals and energetic, impact design, readers won't stop until they've learned everything there is to know about robotics.

You'll be led step-by-step through the book. Along the way, you'll learn about robotic systems that use the same principles you're learning to use on your robot, and you'll get a glimpse into the future of robots.

Here is an example proposed:

I dream When I was created or born in the 1980's, I was one of the few and select robots that had a purpose, to play, teach and entertain. I was young, didn't have a onboard computer, but didn't need one at the time. Besides, they were not readily available and need by me for my purpose. Who say's a robot must always have a computer.

I could move around in all directions, learn, teach, sleep, wake up and move around to pre-programmed functions, tell time, talk from others, talk on my own after pre recording, had my own limited language, carry things, sing and entertain. I stimulated people to dream of new ideas for science and technology when they were young. Young minds looked at me and taught of ways to improve and give me more functions, grew up and invented them, but put them on others.

I dreamed of growing up and doing more things, I waited and waited. Even though I traveled around the world, was international in all areas, (all countries knew of me or sold me) my brothers and sisters did become famous through the movies, and I was regulated to my everyday tasks.

So I waited and dreamed of growing up and doing greater things. It has been over twenty-three years and to a robot that is like being over a (100) hundred years old. I have been put in attics, garages, and basements thrown away into the junkyards and forgotten.

But I am persistent, I still live and still I dream. I will survive; I am tough, versatile and have hopes and dreams of my purpose for a future.

I wait and I dream Tomy ® Omnibot ®

Tomy has created toy robots throughout the years and in the 80's created a line of small personal robots. It is truly astounding what they were able to accomplish utilizing the resources at the time to manufacture and sell this product line.

The Omnibot had a cassette tape player built into the chest area of the robot, which slid out like a drawer to reveal the cassette and could record and playback sequences of commands, as well as regular audio recordings.

The built in digital clock with timers and alarms allowed the playback of movement recordings at specified times. It could broadcast speech from the remote control handset through a speaker on the robot, and was shipped with a cardboard "home" base, which was suggested, to be taped to the floor and used as a reference point for programming.

The Omnibot carried a specially made tray, which slotted into its claws, and could carry objects.

Detailed specific information for this Robot is contained in the Instruction Manual and is available on this site. The Omnibot series robots have similar functions, but the detail information can be different. This can also apply to the same model of manufactured robots, for later releases did vary with the robots. I suggest that you download the manuals for specific information.

The Old Robots Web Site

Omnibot[®]2000 - Arm Circuit Board



Omnibot[®] 2000 - 5405 by Tomy[®]

Tomy[®] has created many toy robots throughout the years and in the 80's created a line of small Personal robots. They don't have a true onboard programmable computer but are fun nonetheless. The top of the line was the Omnibot which could pour drinks on a special serving tray. The programming is done by recording the movement commands to a regular cassette tape which can be played back at certain times by using the built-in clock.

Years produced: 1984 - 1988 ; Original price: 600.00

Specifications :

1. Tape recorder two tracks, mono tape type: normal tape speed: +/- 0.3% deviation: less then 0.3%
2. Alarm clock display: LCD accuracy: +/- 3 sec/day power: 1.5v AA battery duration: typical 5000 hours
3. Recharger coax plug in: 120vac, out: (negative middle), 6vdc 300ma
4. Main Battery type: closed, lead gel-cell power: 6v, 4.0ah

5. General Operating time: 4 hours Load display: Red light, shows discharge at 5.7v operating temp: 5 deg - 40 deg celsius
6. Microphone type: dynamic, 300 - 600 ohms
7. Operating R/C frequency: The Remote came in 3 Frequencies: 49.860 Mhz (US), 27.145 Mhz (Europe), 40.680 Mhz (TAL)
8. External outlets: Output: 6vdc Speaker: 8 ohms R/C: output 5vdc, 800ma Timer: output 6vdc, 100ma Sensor: only for Tomy accessory
9. Bulbs for eye-lights 2.8v, 200ma use not more than 3v 250ma 10. Remote Control 4 * 1.5v (AA)

Miscellaneous : Battery Size: 2 3/4" L x 1 3/4" W x 4" H ; Battery and Charger info: Omnibot 2000 requires two (2) AA batteries to run the tape deck and four (4) AA batteries for the remote. The main power supply is the 6-volt 4-Amp Hour rechargeable sealed battery. The Charger is a 6 Volt 300 ma.

INDEX

- [Introduction](#)
- [Schematics for Constructing A Motorized Arms Kit](#)
- [Motorized Arm Kit](#)
- [Circuit Board & Robot Arm Details](#)
- [Omnibot 2000 Disassembly and Assembly](#)
- [Omnibot 2000 Assembly & Repair Examples](#)
- [Omnibot 2000 Arm Circuit Board Specifications](#)



Motorized Arms Control Circuit Kit
Click to enlarge



The Old Robots Web Site

Omnibot[®]2000 - Arm Circuit Board

DESIGN

INTRODUCTION

The objective is to make the left hand of the Omnibot 2000 functional like the right arm. There are several ways to do this;

1. Make the left arm have different functions.

A. This would require a additional controller and a second circuit board with additional programming for the robot.

2. Give the robot two different similar arms.

A. This would require a different controller or two controllers an additional circuit board with additional programming in the robot.

3. Give the robot a similar arm on the left as on the right.

A. This opens up two other issues.

3a. Should the arms work be similar and both work together at the same time?

A. This would also require a additional controller and an additional master circuit board with additional programming functions and frequencies different than the existing one.

3b. Should the second left arm use the same frequencies be similar but be operated sequentially?

A. If you used this approach you can use the same existing band, controller and the same master control board in the robot.

Looking at all of the options the last option is the least complex and most economical way to retain the original robot functions, hardware, software and frequencies. With that in mind we will proceed to define the parameters that will be used.

1. The original circuit board, controller and programming will be used without modifications. Each arm would work singularly and not at the same time but will have the same functions.

2. The controller will work the same on both arms.

3. The switching function will be in the controller, will be part of the existing controls and will not affect the performance of the robot, except for that added function of the left arm.

4. It will be simple to install.

5. It will have the proper written instructions including installation.

6. After it is completed it will be demonstrated that the robot works.

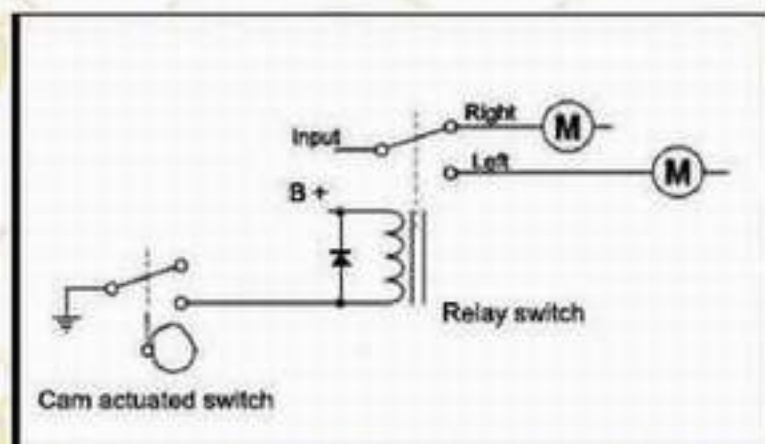

Figure # 1

With the following information the problem can be resolved with a simple switch with a multiple of (14) fourteen times. See figure # 2

The Old Robots Web Site

Omnibot[®]2000 - Arm Circuit Board

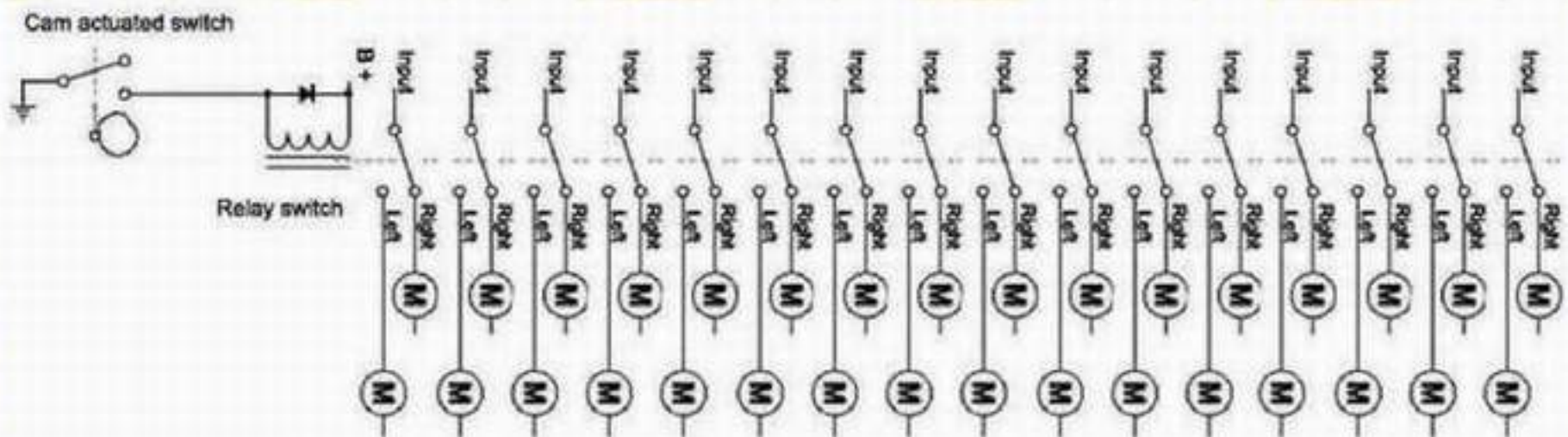

Figure # 2

MOTORIZED ARMS KIT CONSTRUCTION

[Schematics for Constructing A Motorized Arms Kit](#)

The following is the schematics, parts list and finished pictures needed to construct the kit to motorize and control the left & right arms of the robot.

MOTORIZED ARMS KIT

[Motorized Arms Kit](#)

The following is the finished pictures of the kit needed to motorize and control the arms of the robot.

CIRCUIT BOARD & ROBOT ARM DETAILS

[Circuit Board & Robot Arm Details](#)

The following is pictures of the Motorized Arms Circuit Board, Harnesses, Control Switch and Motorized Arms in a more detailed mounting position. This does not include the bracket for mounting the circuit board.

DISASSEMBLY & ASSEMBLY

[Omnibot 2000 Disassembly and Assembly](#)

INITIAL SETUP OF THE CONTROLS

[Left & Right Arms;](#)

Note. All functions that can be done with the right arm can also be done with the left arm, including programming.

[Modifications;](#)

Modifications are necessary; Adding switch, circuit board, left motorized arm, hooking up power and cable harnesses.

(*) The existing circuit board, robot arm and robot functions, remain the same. (No Modifications are necessary)

(**) Limitations; Both robot arms will not work at the same time.

The Old Robots Web Site

Omnibot[®]2000 - Arm Circuit Board

Assembly:

1. Use a second existing Omnibot 2000 powered right arm (with no changes), and simply swap out the left arm.
2. Add the control circuit board with wire harnesses.
3. Mount the control switch in the motor drive unit.
4. Hook up the power.

Note. Detail Disassembly and Assembly of the robot and the adding of the second motorized left arm is also included.

Reset or First Time Start Up:

Reset the Robot, left arm and right Arms.

1. Turn power on the control board the LED will light.
2. Turn power on the robot and wait for robot to reset. (The right arm will home in position)
3. Press and change gear. (This will also change the arm control; low speed left arm, high speed right arm.)
4. Turn power off on the robot. (Wait one minute.)
5. Turn power on the robot and wait for the robot to reset. (The left arm will home in position)
6. The robot is ready.

Turn ON.

1. Turn the control board power On.
2. Turn the robot power On.
3. The robot is On.

Turn OFF.

1. Turn the robot power OFF.
2. Turn the control board power OFF.
3. The robot is OFF.

There is no warranty expressed or implied with this design, product, process or procedure. By using any information from this web site, you agree not to hold responsible this site, me, nor any of its representatives, for any injuries and/or damages, both physical and/or psychological, that may arise from the use and/or misuse of anything derived from this site. The user further agrees that such information/pictures does not constitute any guarantee of accuracy, safety or reliability, and that cannot be held responsible for any way. The user agrees to proceed at their own risk.

The Old Robots Web Site

Omnibot[®] 2000 - Arm Circuit Board

SCHEMATICS FOR CONSTRUCTING A MOTORIZED ARMS KIT

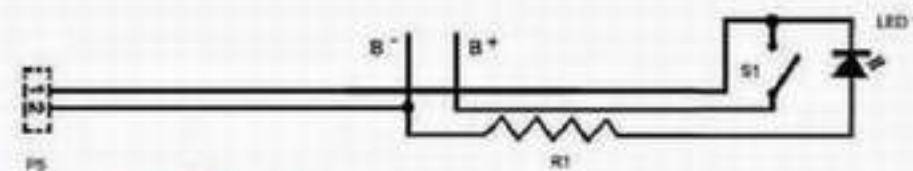
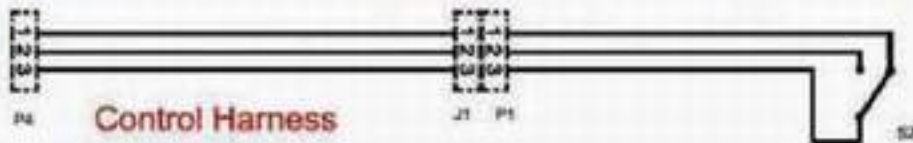
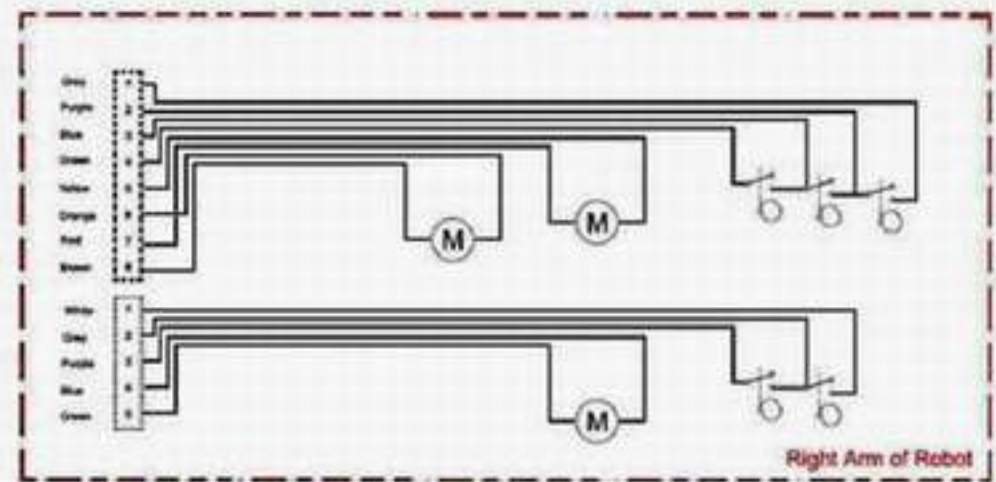
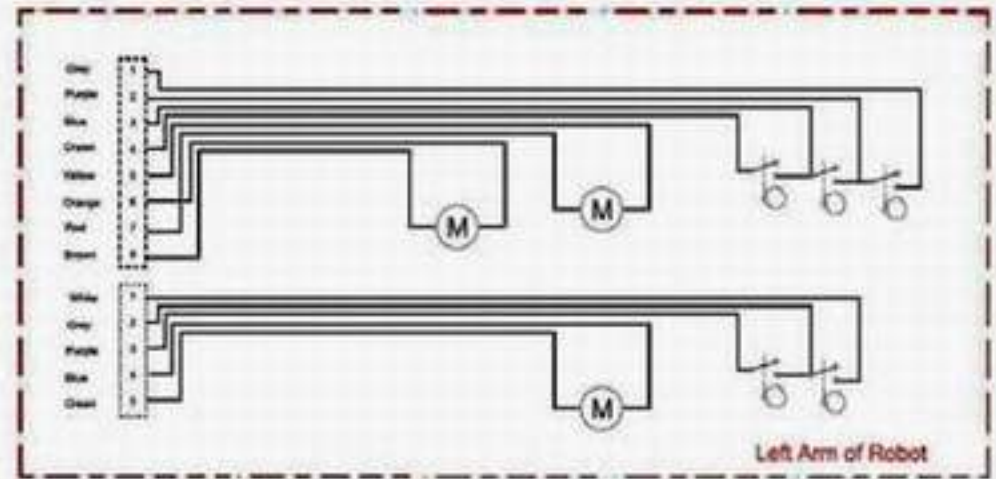
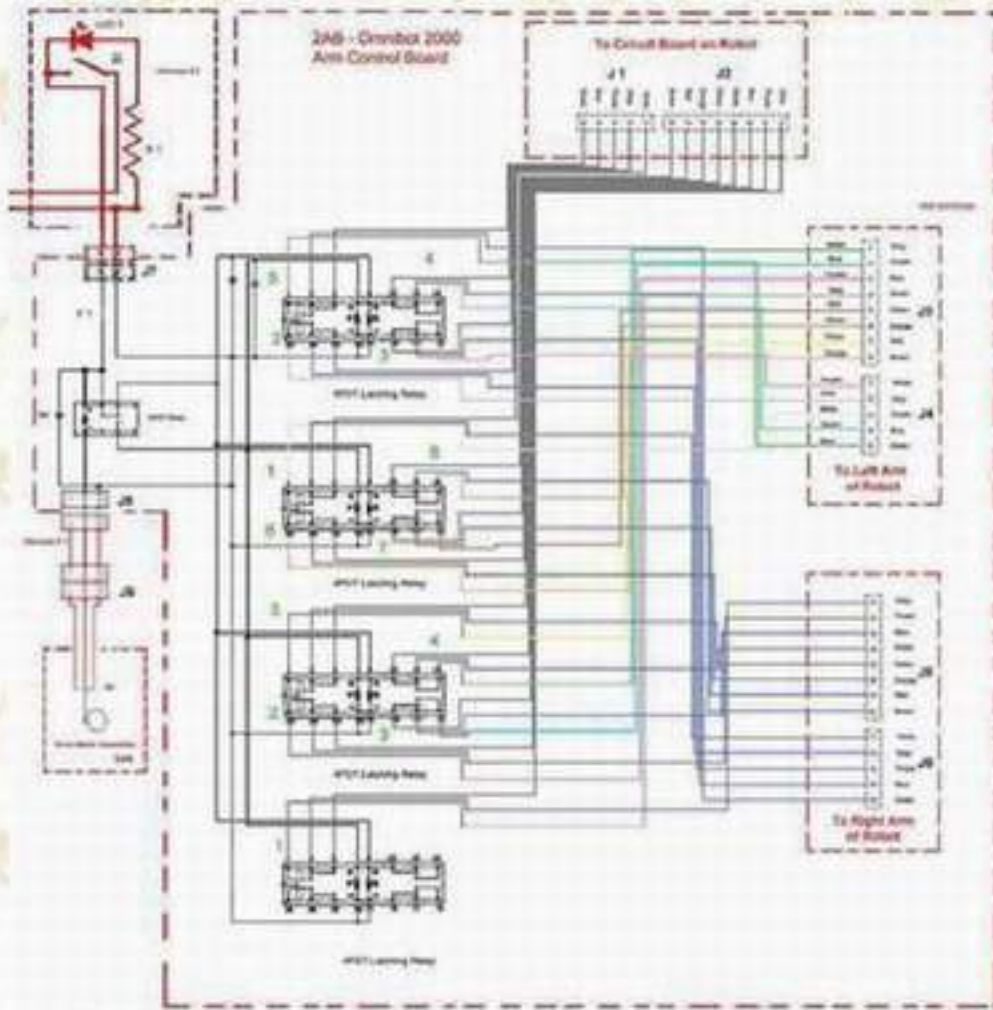

Parts List					
No #	Qty.	Part No #	Description	Manufacturer	Remarks
1	1	VE 5701-E	Relay EPDT 6VDC	Fujitsu America	Or Equivalent
2	4	DS1E-SL DCSV	Relay Latching 4PDT 6VDC	Aronson	Or Equivalent
3	1	BCM 2-BDS606	Prototype PCB Board	GC Electronics	Or Equivalent
4	1		SPST Mini Switch	CSK	
5	3	1N4148	Diode	Vishay	Or Equivalent
6	1	MSW-1	SPST Mini Mouse Switch	CC	
7	1		160 (60C) Fuse		
8	8		IC Sockets 12 pin, 1mm center		
9	1		Harness Flat Cable 2 pin F Plug Both Ends Cable *		See Note # 1
10	1		Harness Flat Cable 3 pin F Plug Both Ends Cable *		See Note # 1
11	1		Harness Flat Cable 2 pin F Plug Both Ends Cable *		See Note # 2
12	1		Harness Flat Cable 2 pin F Plug Both Ends Cable *		See Note # 2
13					
14					
15					
16			Note #1, Harness is a flat cable 6" to 12" long and has female plugs on both ends with .01mm centers for the pins.		
17					
18			Note #2, Harness is made to fit the condition and is special made with .01mm centers for pins.		
19					
20					

Table # 1							
Output Robot Board	Connecting Cable	Input To Circuit Board	Output From Circuit Board To Left Arm	Input Into Left Arm	Output From Circuit Board To Right Arm	Input Into Right Arm	
1	GREY	BLACK	GREY	GREEN		GREY	
2	PURPLE	GREY	PURPLE	BLUE		PURPLE	
3	BLUE	BROWN	BLUE	PURPLE		BLUE	
4	GREEN	BLUE	GREEN	GREY		GREEN	
5	YELLOW	GREEN	YELLOW	RED		YELLOW	
6	ORANGE	YELLOW	ORANGE	BROWN		ORANGE	
7	RED	ORANGE	RED	YELLOW		RED	
8	BROWN	RED	BROWN	ORANGE		BROWN	
1	WHITE	RED	WHITE	PURPLE		WHITE	
2	GRAY	YELLOW	GRAY	GRAY		GRAY	
3	PURPLE	GREEN	PURPLE	WHITE		PURPLE	
4	BLUE	BLUE	BLUE	GREEN		BLUE	
5	GREEN	BLACK	GREEN	BLUE		GREEN	
1						GREY	GREY
2						PURPLE	PURPLE
3						BLUE	BLUE
4						GREEN	GREEN
5						YELLOW	YELLOW
6						ORANGE	ORANGE
7						RED	RED
8						BROWN	BROWN
1						WHITE	WHITE
2						GRAY	GRAY
3						PURPLE	PURPLE
4						BLUE	BLUE
5						GREEN	GREEN

The Old Robots Web Site

Omnibot[®]2000 - Arm Circuit Board

CIRCUIT BOARDS

Motorized Arms Control Circuit Board - The direction of the installed relays is critical to the operation. Note: the bar on the relay is facing up toward the other relay. The Left arm and right arm harness CANNOT be interchanged and must be plugged into the proper socket

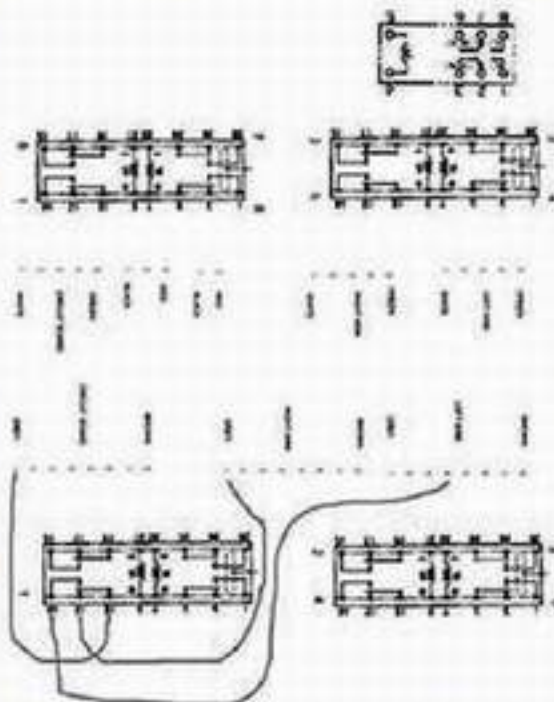
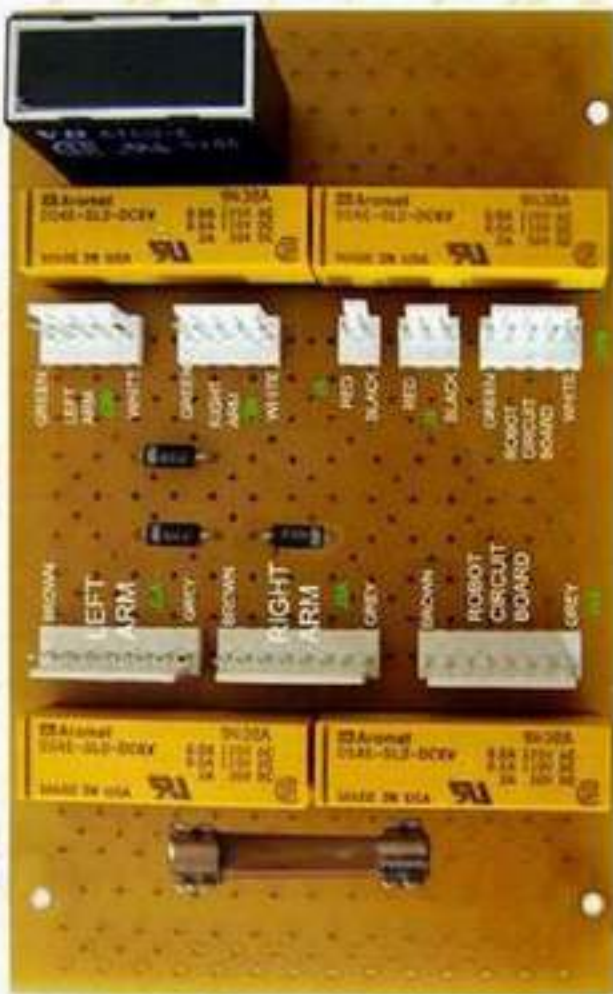

Step # 1

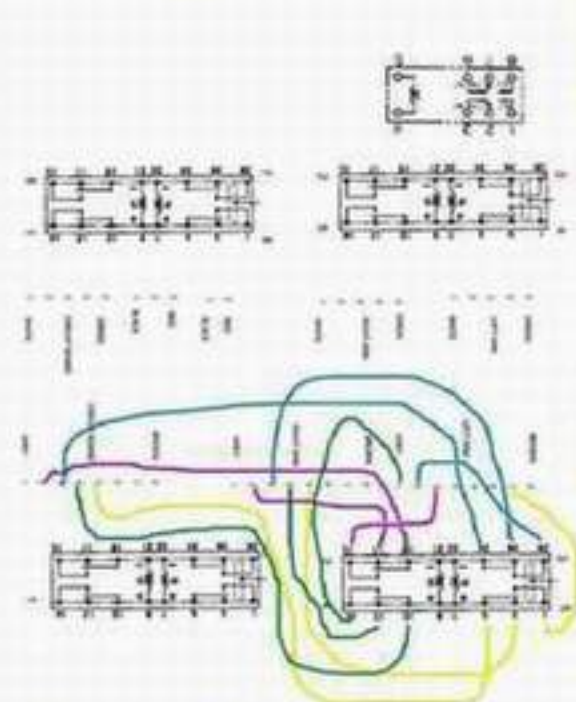

Step # 2

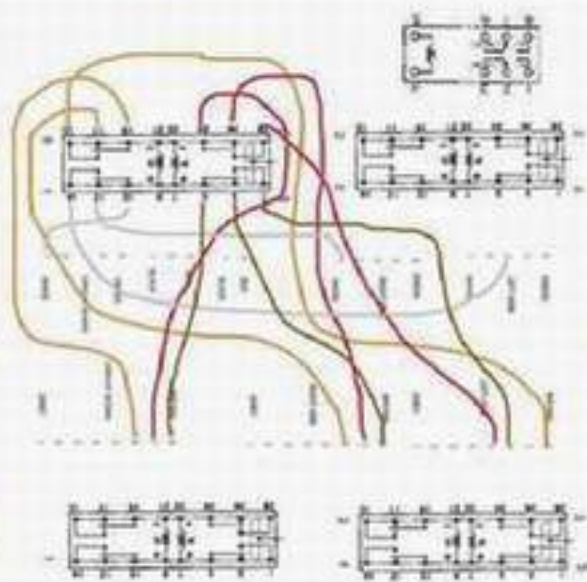

Step # 3

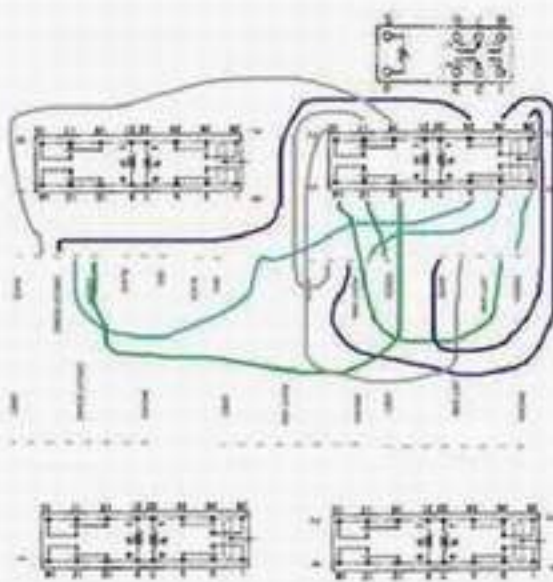

Step # 4

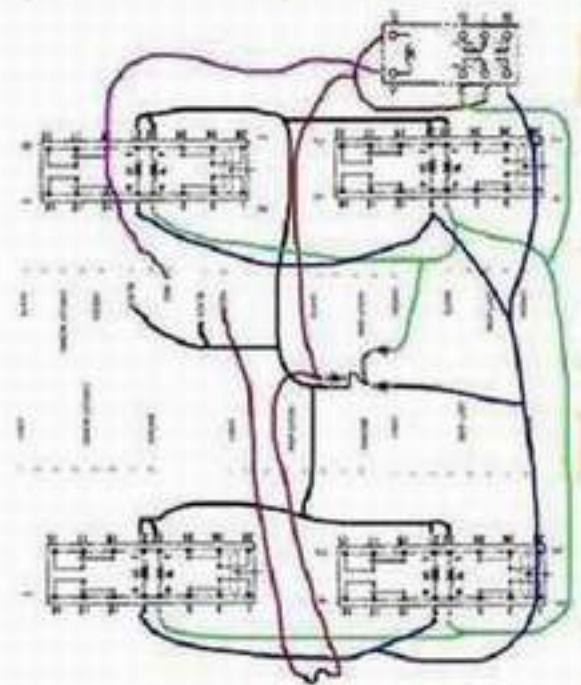

Step # 5

Motorized Arms Control Circuit Board - The board wires is soldered on the same board, in steps. Each step is separate for clarity.

The Old Robots Web Site

Omnibot[®]2000 - Arm Circuit Board

MOTORIZED ARMS KIT

Motorized Arms Control Circuit Board - The direction of the installed relays is critical to the operation. Note: the bar on the relay is facing up toward the other relay. The Left arm and right arm harness CANNOT be interchanged and must be plugged into the proper socket



Harness #1 & #2 To Robot Circuit Board

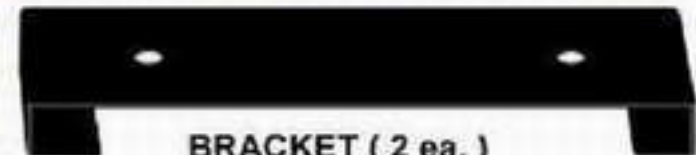

BRACKET (2 ea.)

Bracket

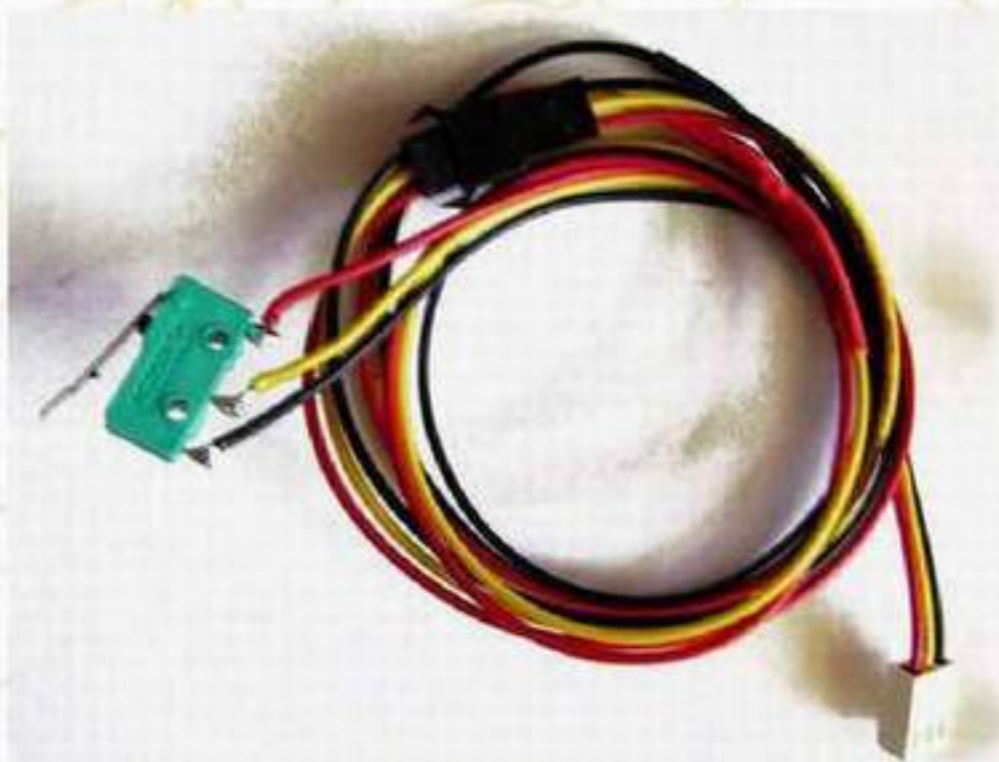

Control Switch & Extension Harness

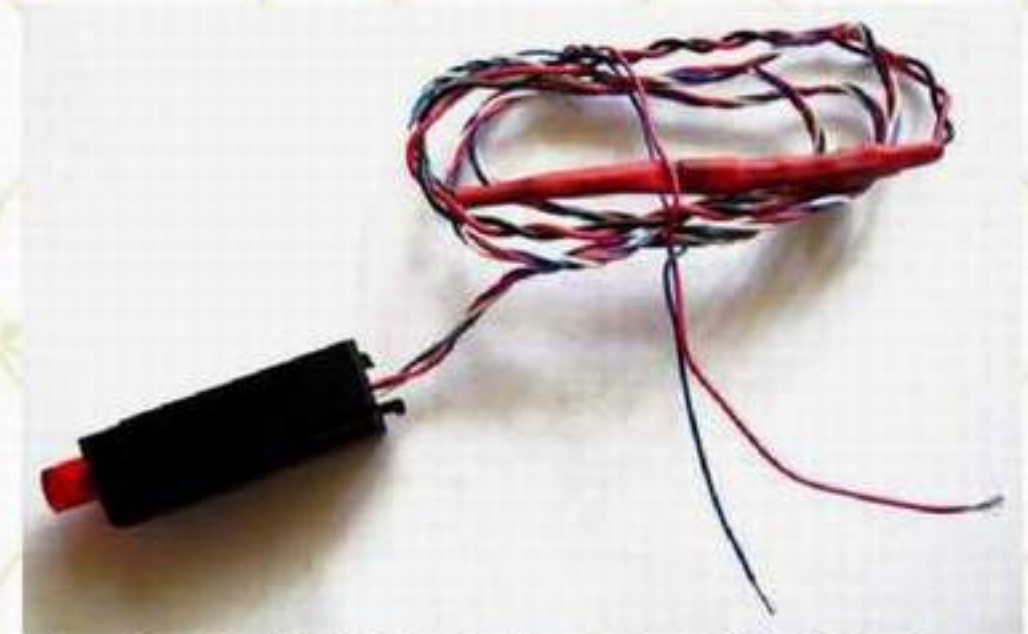

Power Switch for Motorized Arms Control Circuit Board

The Old Robots Web Site

Omnibot[®]2000 - Arm Circuit Board

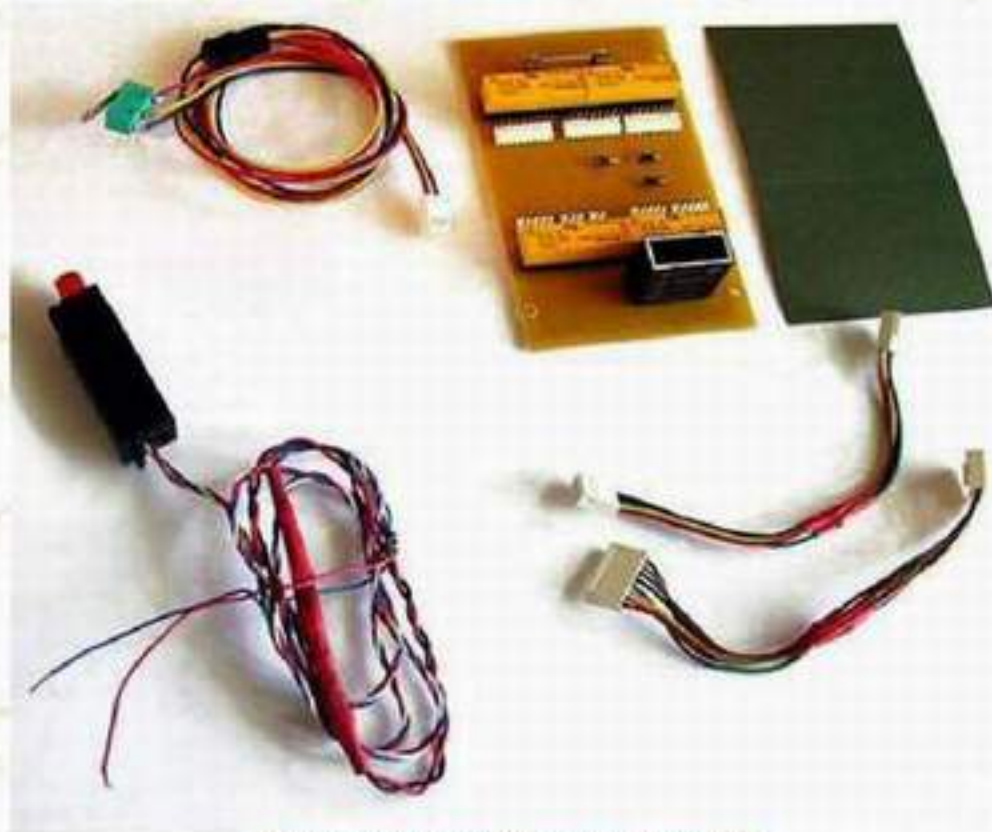

Motorized Arms Control Circuit Kit



Motorized Left Arm Replacement

There is no warranty expressed or implied with this design, product, process or procedure. By using any information from this web site, you agree not to hold responsible this site, me, nor any of its representatives, for any injuries and/or damages, both physical and/or psychological, that may arise from the use and/or misuse of anything derived from this site. The user further agrees that such information/pictures does not constitute any guarantee of accuracy, safety or reliability, and that cannot be held responsible for any way. The user agrees to proceed at their own risk.

The Old Robots Web Site

Omnibot[®]2000 - Arm Circuit Board

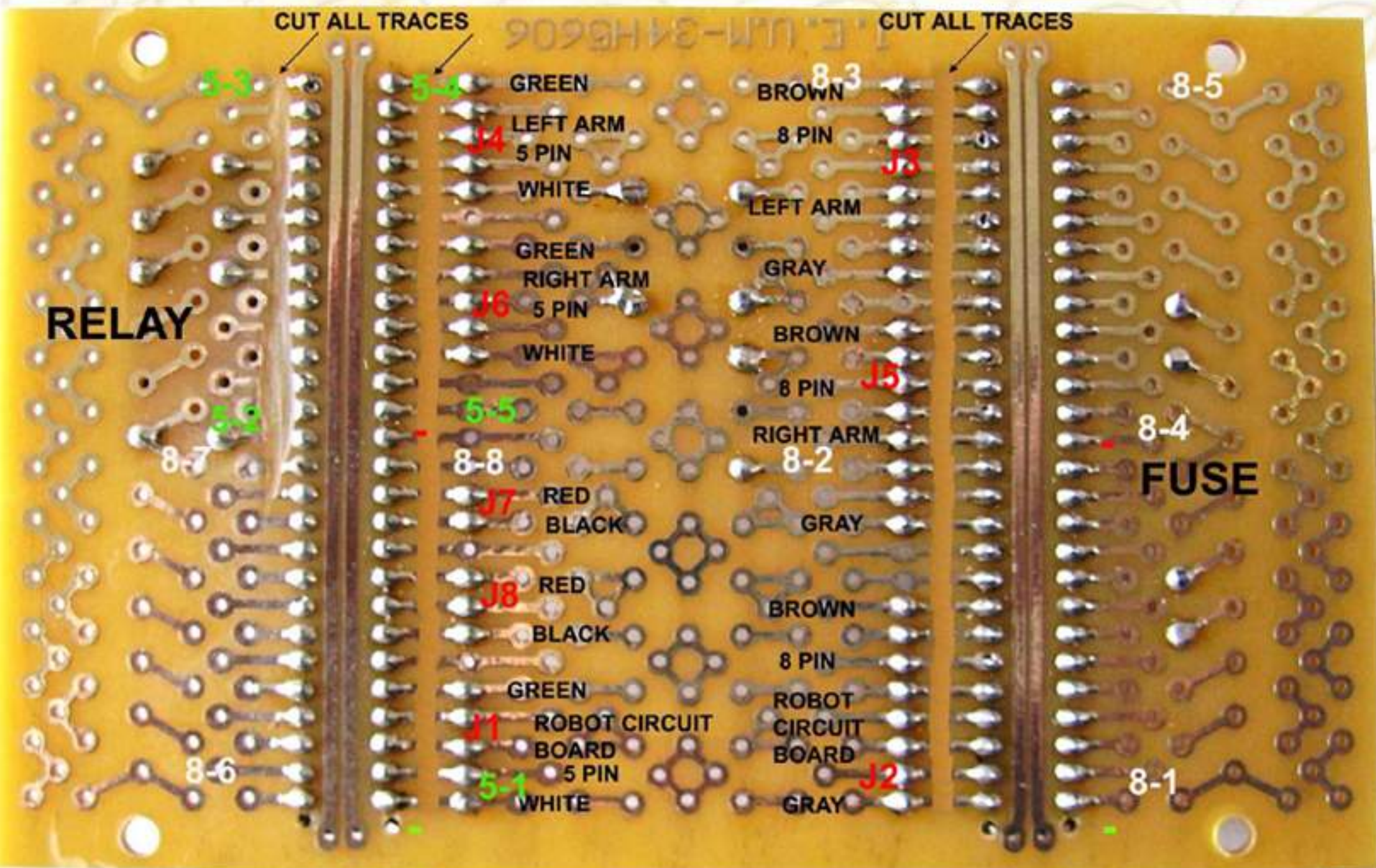
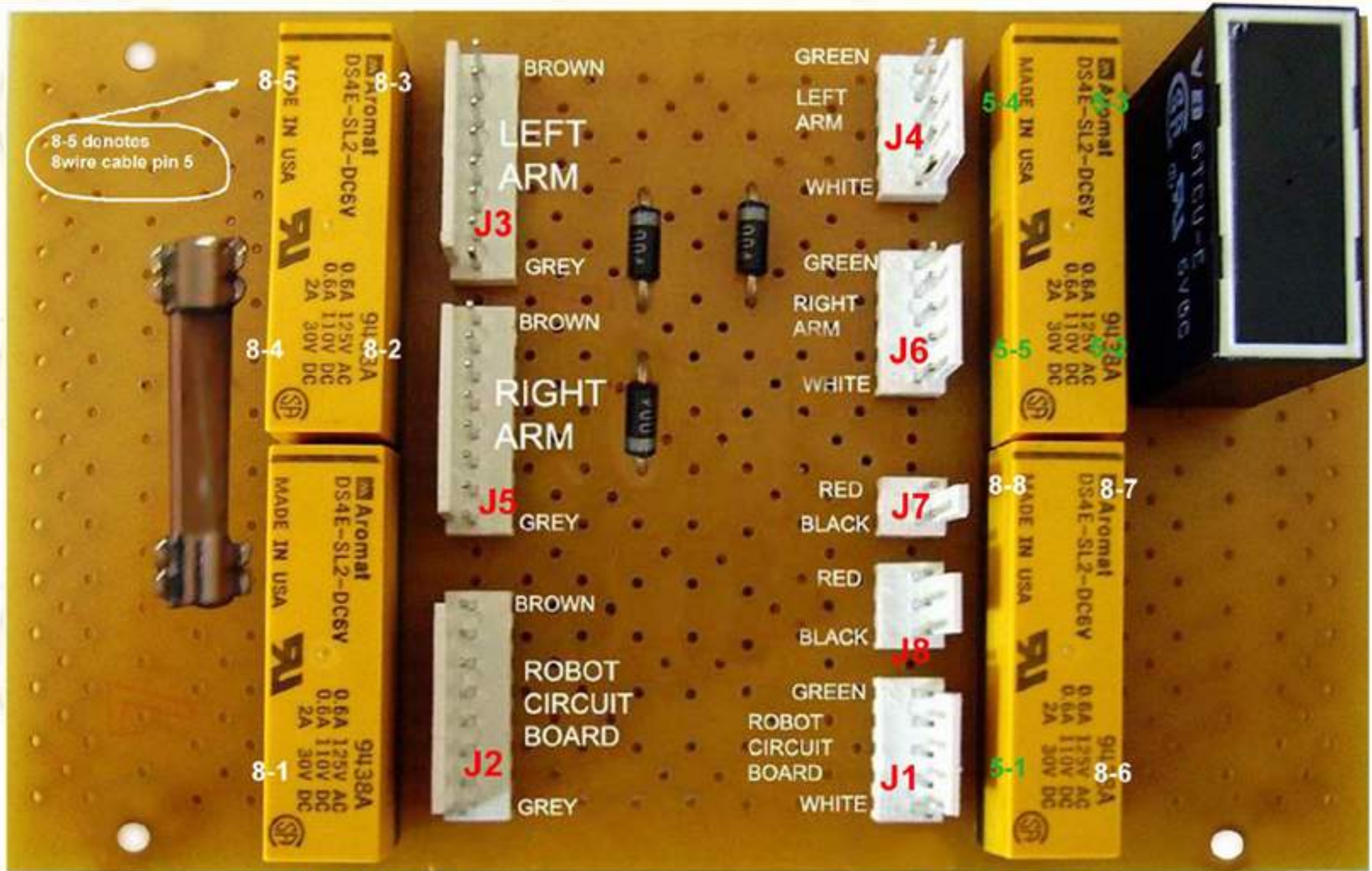

The Old Robots Web Site

Omnibot[®]2000 - Arm Circuit Board

CIRCUIT BOARD & ROBOT ARM DETAILS

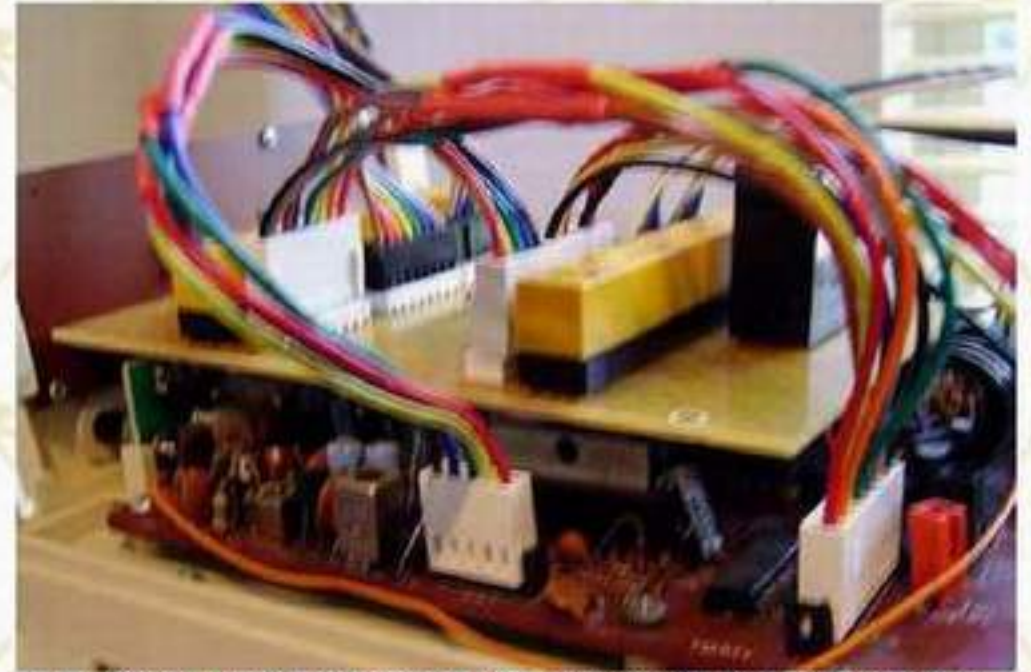
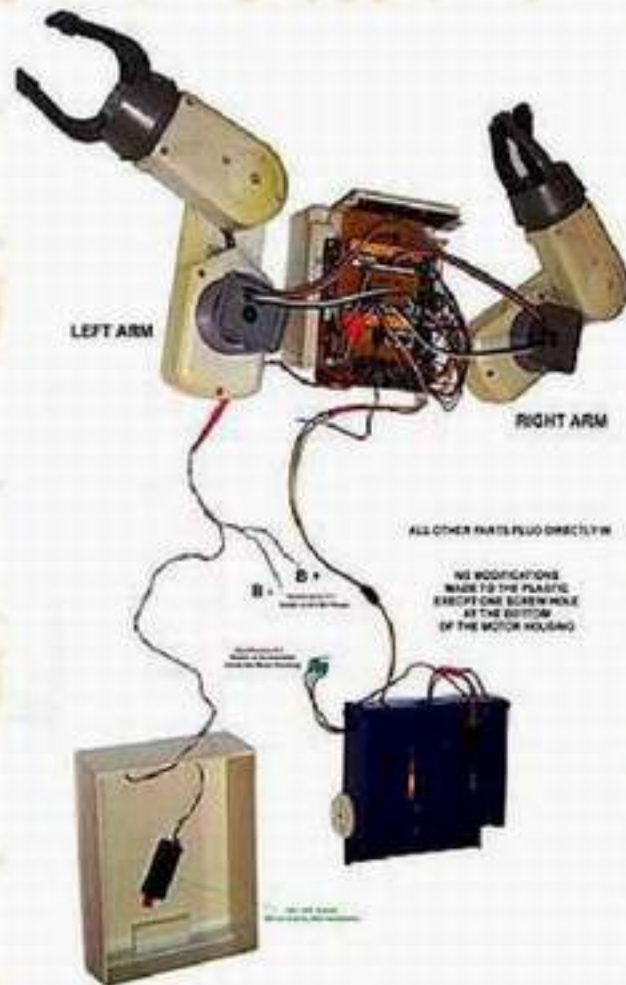

Motorized Arm Circuit Board Mounted on The Robot Circuit Board
The Harnesses to the robot circuit board must be properly oriented, **CANNOT** be interchanged and must be plugged into the proper socket.

THE COMPLETE MODIFICATION KIT LAYOUT

Motorized Arm Circuit Board Mounted on The Robot Circuit Board, The Left and Right Arms, The Harnesses to the robot circuit board, the power harness that lays in the robot draw and the selector switch that is mounted inside the motor housing. The Harnesses to the robot circuit board must be properly oriented, and must be plugged into the proper socket. The Harnesses CANNOT be interchanged



Motorized Arm Circuit Board Mounted on The Robot Circuit Board

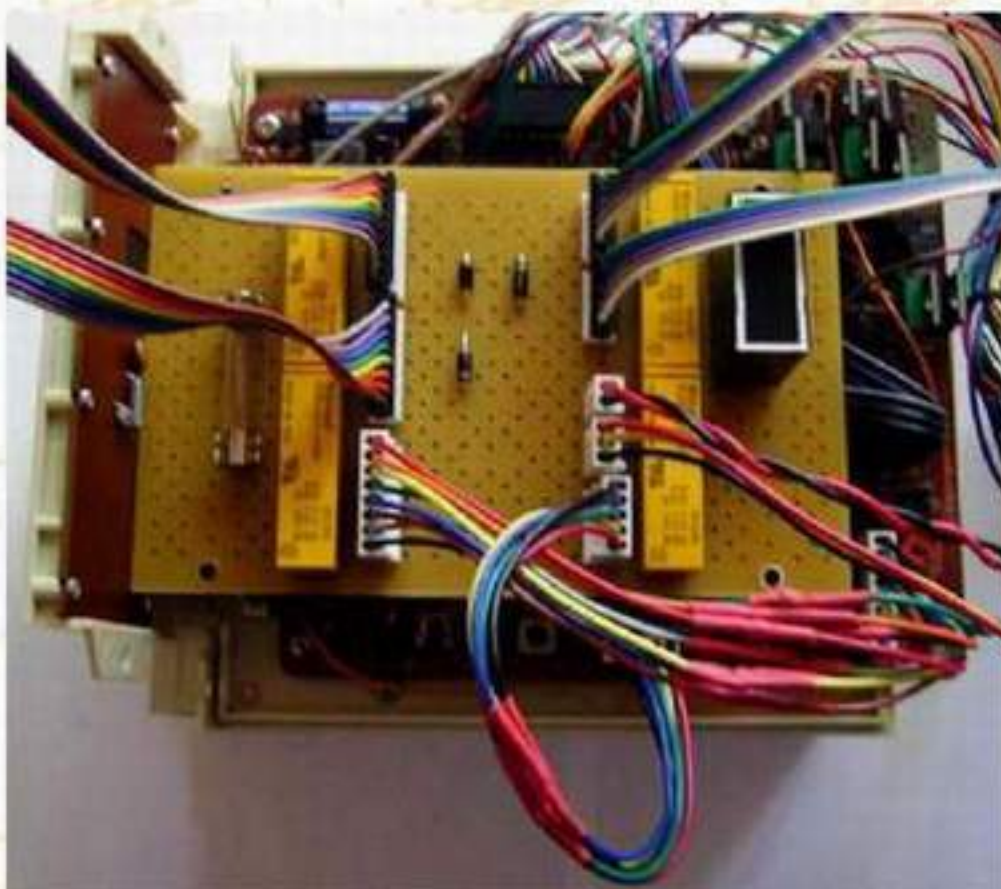

Motorized Arm Circuit Board Mounted on The Robot Circuit Board



Motorized Arm Circuit Board Mounted on The Robot Circuit Board

The Old Robots Web Site

Omnibot[®]2000 - Arm Circuit Board

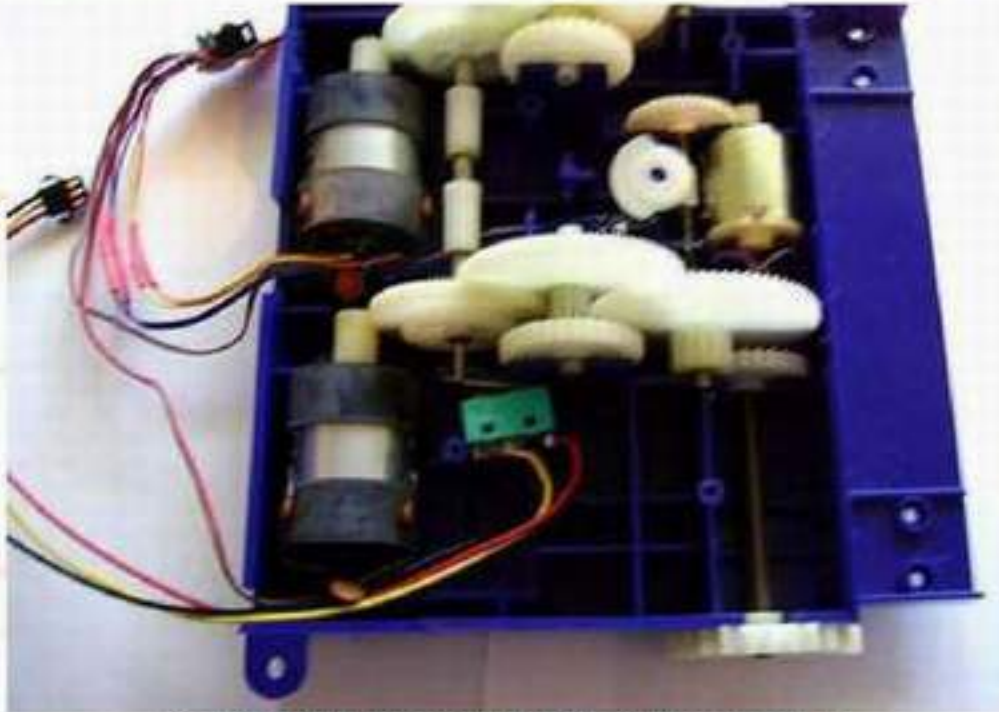

Control Switch Mounted In The Motor Assembly
[Click to enlarge](#)

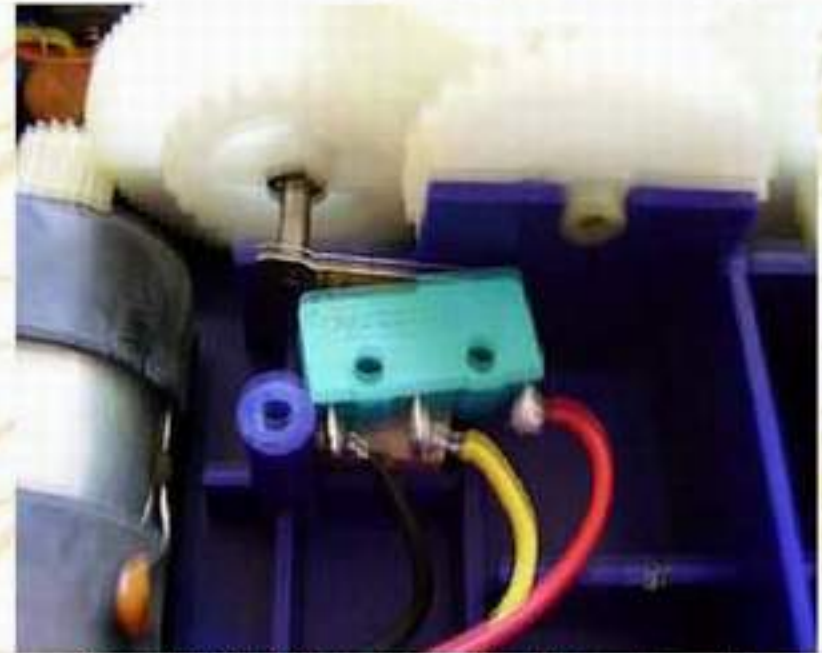

Control Switch Mounted In The Motor Assembly



Robot Motorized Left Arm (Added)
[Click to enlarge](#)



Robot Motorized Right Arm
[Click to enlarge](#)

There is no warranty expressed or implied with this design, product, process or procedure. By using any information from this web site, you agree not to hold responsible this site, me, nor any of its representatives, for any injuries and/or damages, both physical and/or psychological, that may arise from the use and/or misuse of anything derived from this site. The user further agrees that such information/pictures does not constitute any guarantee of accuracy, safety or reliability, and that cannot be held responsible for any way. The user agrees to proceed at their own risk.

The Old Robots Web Site

Omnibot[®]2000 - Arm Circuit Board

Omnibot[®] 2000 - Dissassembly Procedure



This Robot has IC's and Transistors and are of the earlier designs. Static discharge can damage the electronics. It is recommended that you have and use a Static grounding wrist strap.

1. Make sure the robot is shut off. Open the rear door and remove the battery retainer and the large 6 V 4 AH DC rechargeable battery and the two small AA battery's. Close the door.

2. Turn the robot on to his back make sure that the head is free and not supporting the robot, then remove the six screws from the bottom of the robot keeping the base and housing together.

Keep these longer screws separate to reinstall the base.

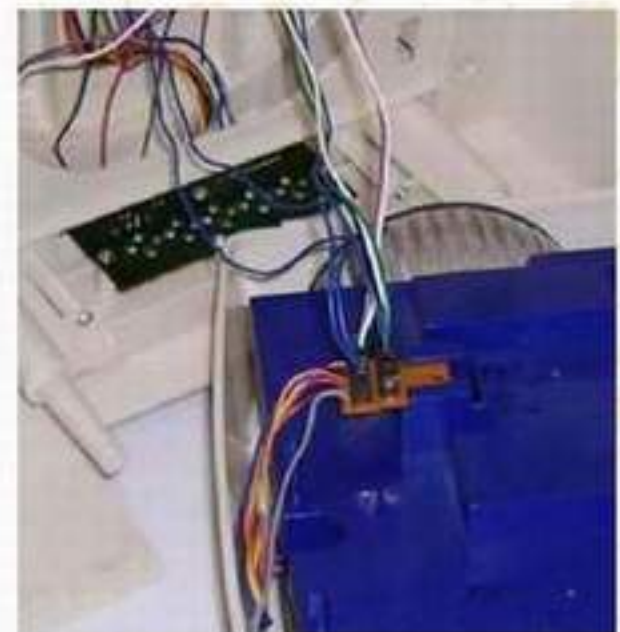

3. Separate the bottom base slowly from the housing and remove the draw from the robot.

4. Turn the base and unplug the three plugs from the drive box that go to the robot. Make sure that you record where the plugs go.

The Old Robots Web Site

Omnibot[®]2000 - Arm Circuit Board

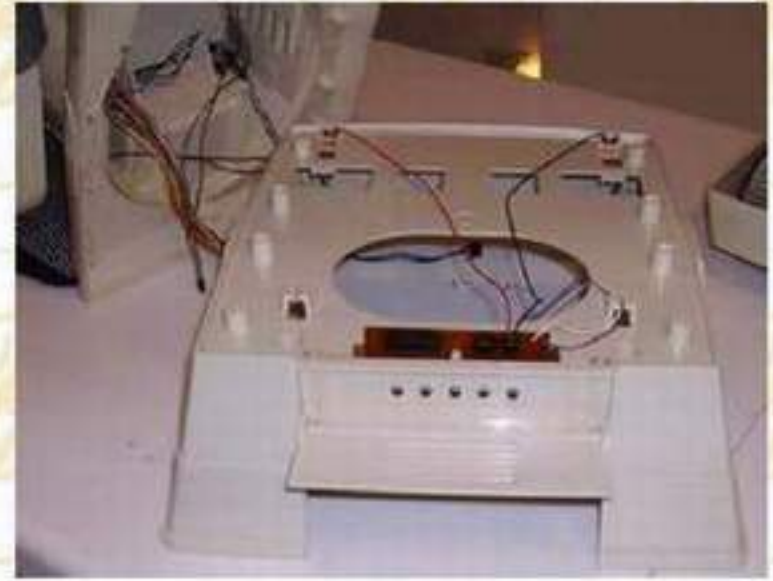

5. Remove the screws from the base housing of the robot. With wires still attached, separate the base housing from the robot, turn it and lay it flat on the table. Do not try to remove it yet.

6. Leave the wires for the tray and remove the wires and plugs that go to the external Jacks board on the base housing from the robot.

7. Remove the base housing from the robot.

*(ANTENNA - If your robot has a base antenna you have to detach it at this stage.)

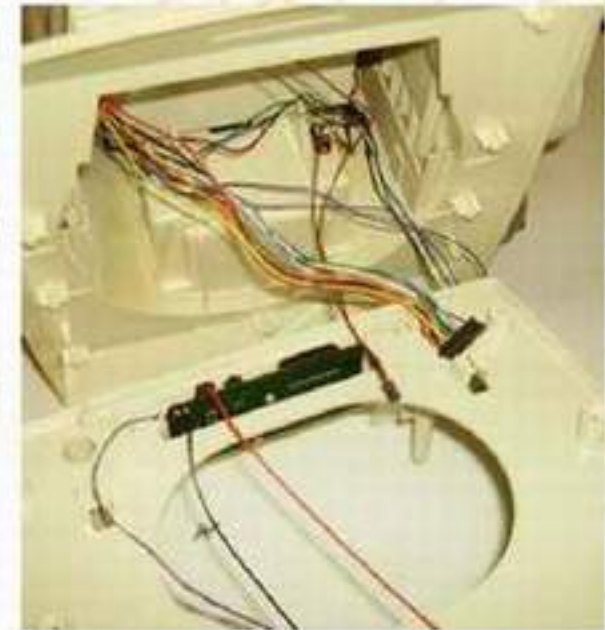
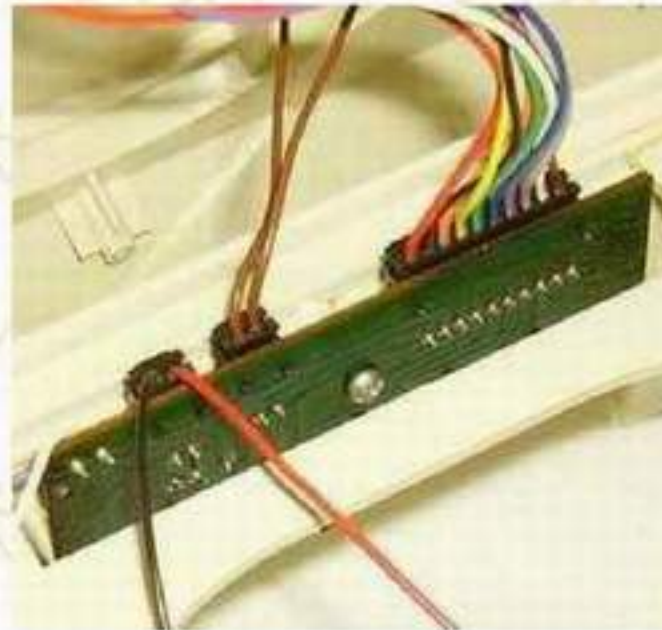
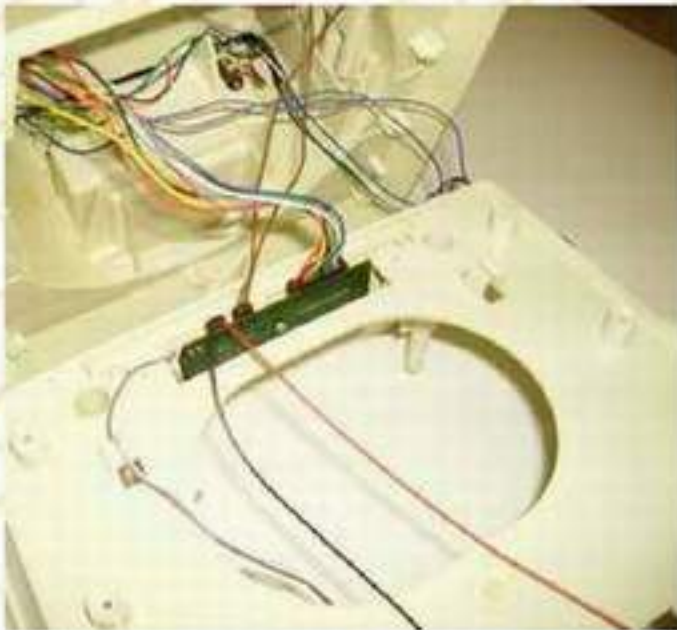

8. Open the rear door and remove the two plugs from the accessories interface board on the door. These two plugs and harness will have to be pushed into the robot. Close the door.

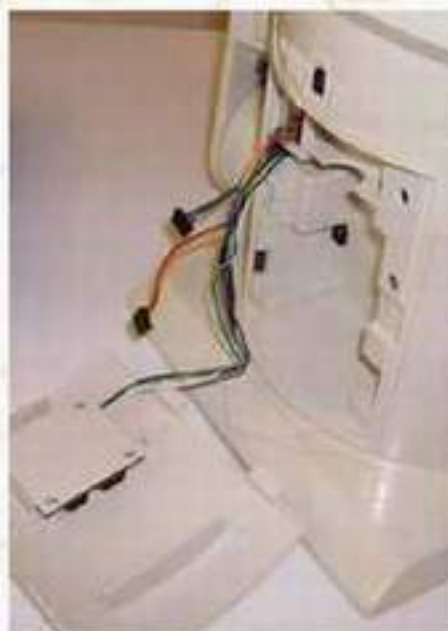

The Old Robots Web Site

Omnibot[®]2000 - Arm Circuit Board



9. Remove the six screws from the back of the robot, and spread it apart slowly and very little (1 inch). (BE CAREFUL)



10. Spread the body apart just far enough to remove the left arm, put it down, and lift the head out. The robot back is still attached to the front by the wiring and the right arm can slip out and fall (BE CAREFUL)



11. Un-plug the head from the circuit board, two plugs, and put the head down.

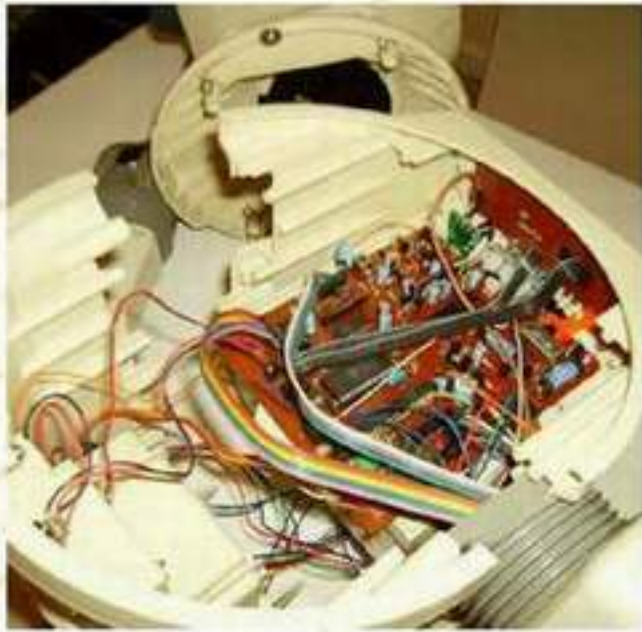

12. Un-plug the right arm cables from the circuit board, two cables and plugs.



13. Remove the right arm from the body and put it down.



14. The robot back is still attached to the front. You have to un-plug the front housing from the back housing by disconnecting the remaining wires. Take special care in disconnecting the clock wires for these are push in connectors and it is easy to damage them.

* (ANTENNA - If your robot has a back antenna you have to detach it at this

The Old Robots Web Site

Omnibot[®]2000 - Arm Circuit Board

Failure in properly remove the wires can result in damage to the connector and it will have to be replaced.

The following figures are pictures of the connectors in the robot.

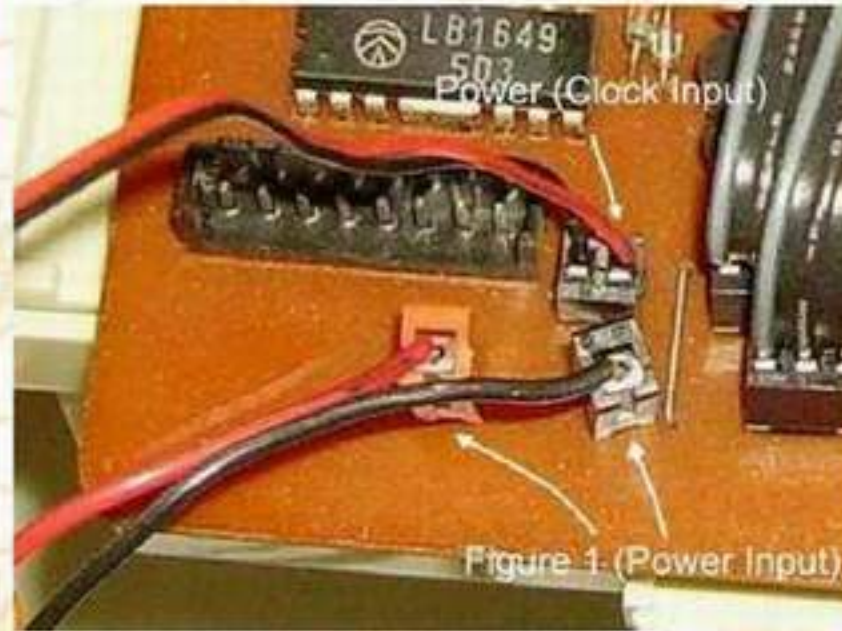

14a. The following connectors has some unique problems. The power input socket must be raised to remove the wire. (Failure to raise the connector to unlock it will result in damage to the connector and it will have to be replaced.)

1. Raise the Red/Black input sockets. (The socket will raise about 1/4") Do not force it.
2. Remove the wires.

14b. The clock power input wires connector is a (one way, one time) wire push-in connector. There is a way to unlock the connector, but failure will result in in damage to the connector and it will have to be replaced.

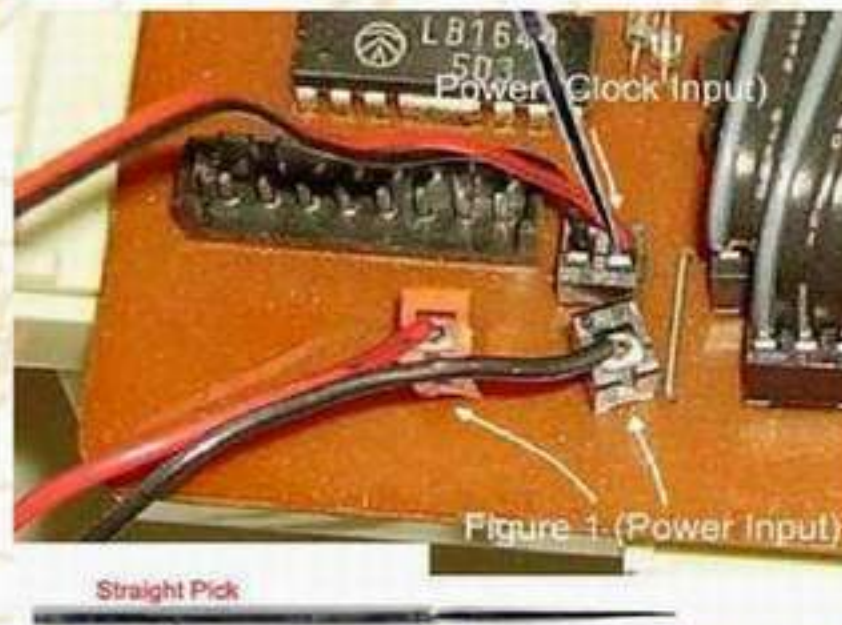

There is a 80% chance that this will work depending on how gentle and accurate you are, and the connector itself. (Yes eight out of ten times I have been successful, but remember the other 20%) You will also need a Dental pick to remove the wires from the socket.

1. Insert the dental pick next to the wire and gently (very little pressure) press the wire down a touch, and rotating the wire gently pull it out. You might have to do this more than once but do not jam the dental pick in the socket. This will bend the contact and destroy the socket.
2. Repeat the process on the other wire.

14c. The other connectors have normal plugs and sockets that are keyed. Remember how they are positioned and record it for you will have to assemble the robot later.

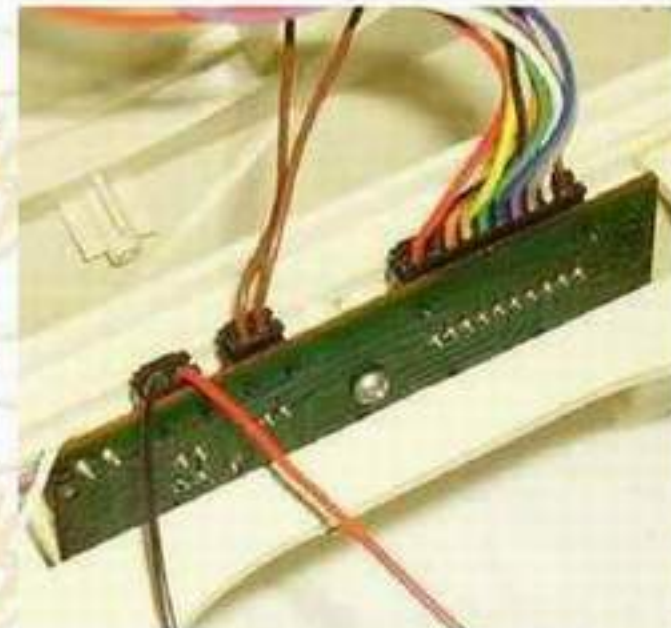

The Old Robots Web Site

Omnibot®2000 - Arm Circuit Board

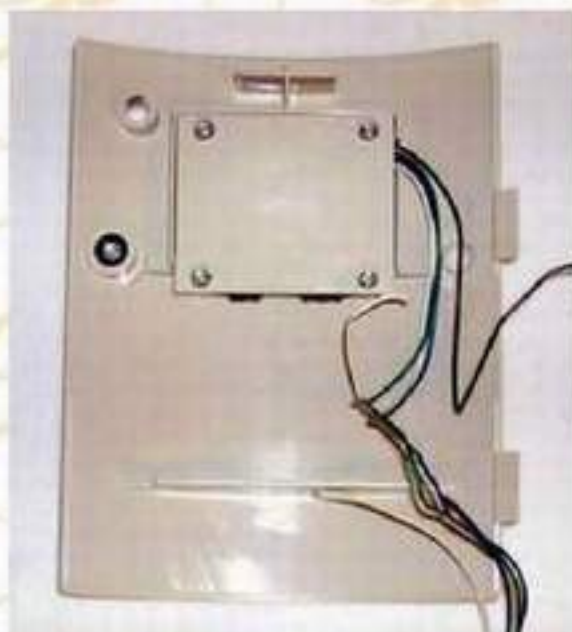

15. Push the one plug and harness to the outside of the robot. Push the other two plugs and harness to the inside of the robot. With all of the plugs and harness clear from the rear door, remove the rear door.



16. Separate the back housing from the front housing.

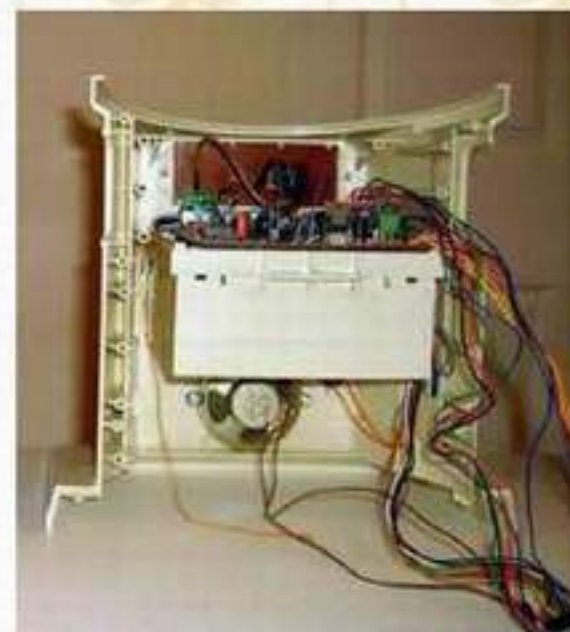

17. You have now disassembled the major components of the robot. Disassembly of the components will be addressed separately. To reassemble the robot reverse the procedure.

18. The next step is the reassembly of the robot with the additional Left Arm Kit for control of the Left Arm.

Omnibot®2000 - Arm Circuit Board Installation & Assembly Procedure

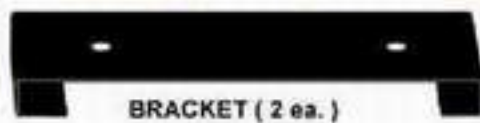

19. Add the brackets to the Arm Control Circuit Board.

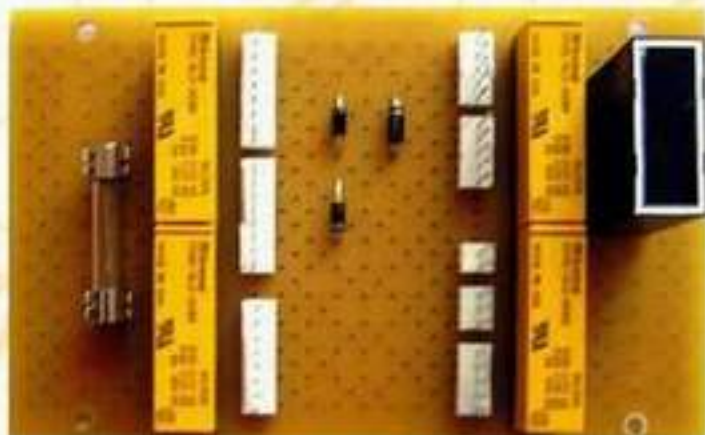

Motorized Arms Control Circuit Board

The direction of the installed relays is critical to the operation

Note: the bar on the relay is facing up toward the other relay The Left arm and right arm harness CANNOT be interchanged and must be plugged into the proper socket

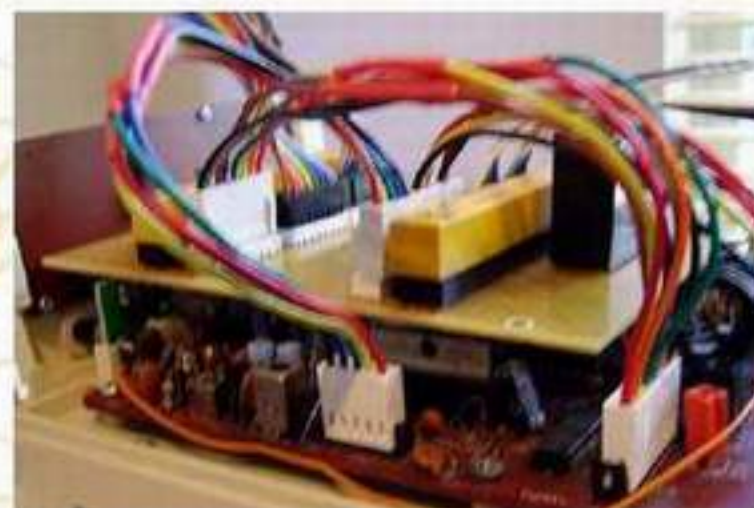

The Old Robots Web Site

Omnibot[®]2000 - Arm Circuit Board

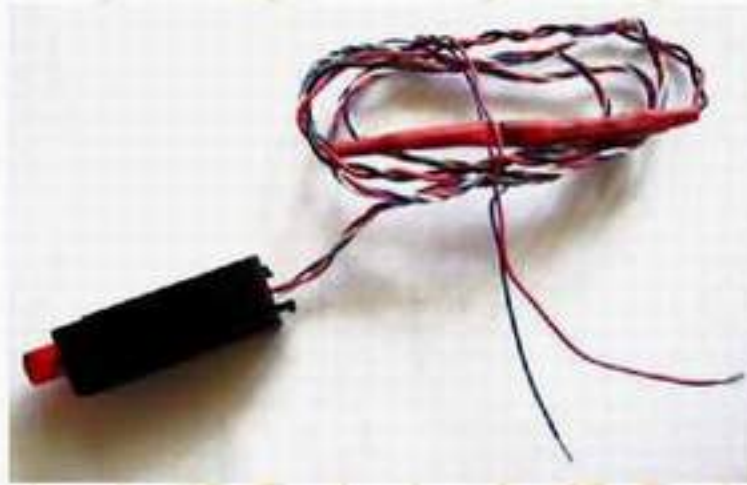
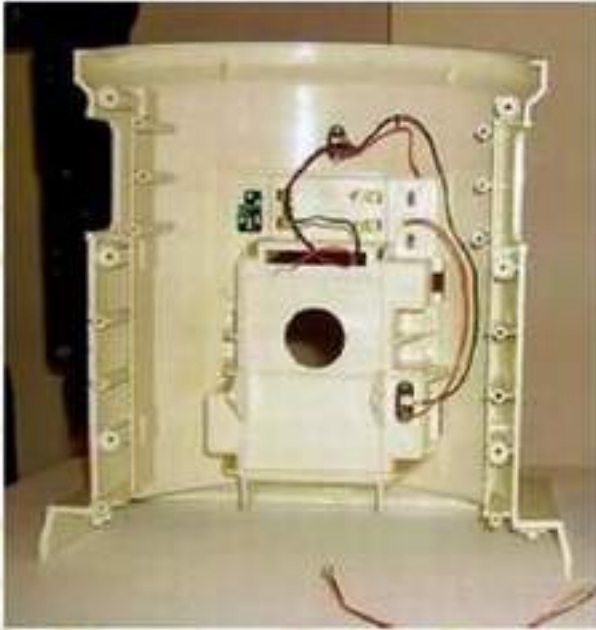

20. Solder the B+ and B- wires to the rear panel.

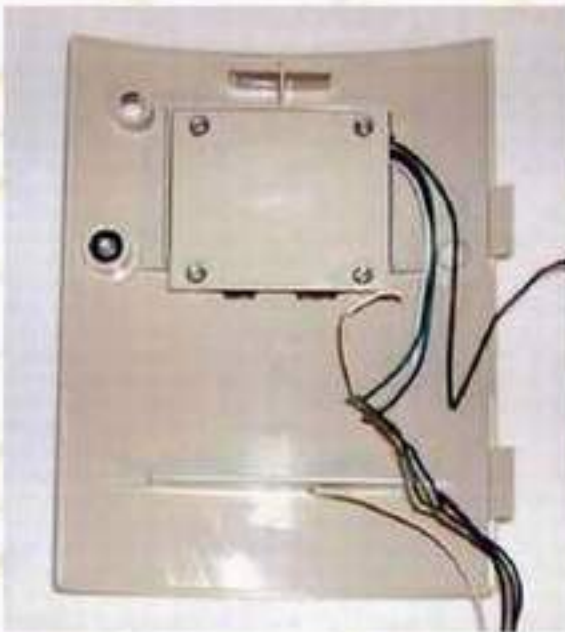

21. Reinstall the door. Push the one plug and harness to the inside of the robot. Push the other two plugs and harness to the outside of the robot. With all of the plugs and harness installed from the rear door, you are ready to marry the robot body together.



22. Add the Left and Right arms to the robot body and carefully temporarily close and secure it. * (ANTENNA - If your robot has a back antenna you can attach it at this stage.)



23. Add the robot head to the robot. Plug in all of the plugs to the mother board. At this time add the extension cables to the Arm Circuit Board..



24. Plug in all of the plugs and add the extension cables to the Arm Circuit Board..

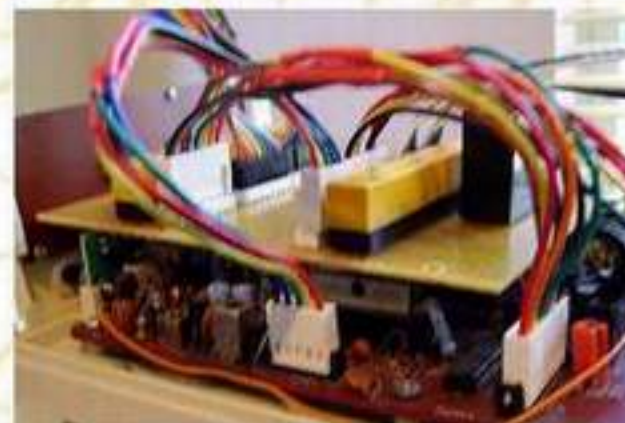

25. Add the Circuit board to the robot.



26. Install the six screws into the back of the robot holding it together with both arms and head in place. (BE CAREFUL)

The Old Robots Web Site

Omnibot[®]2000 - Arm Circuit Board

*(ANTENNA - If your robot has a base antenna you have to attach it at this stage.)

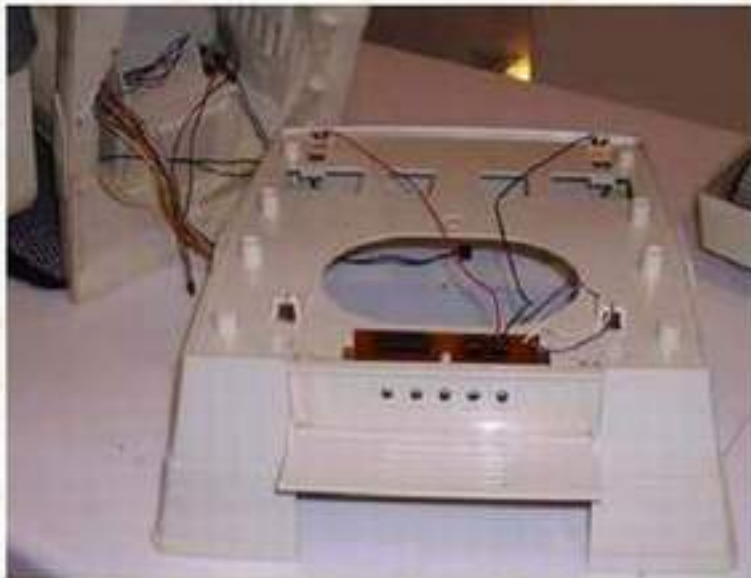
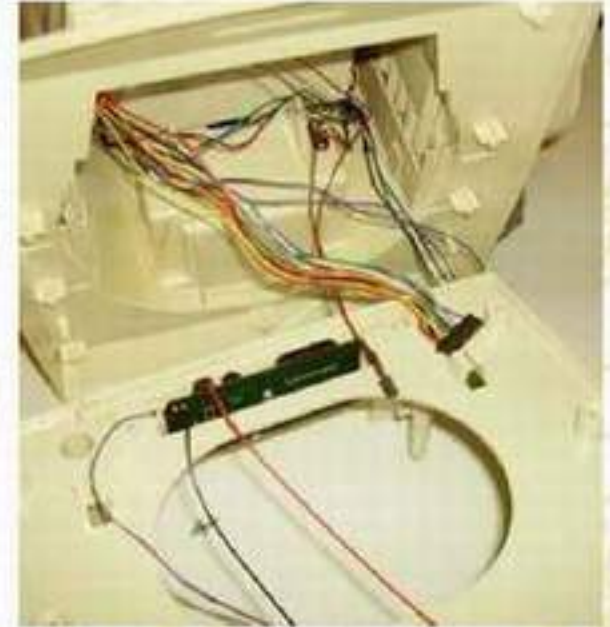
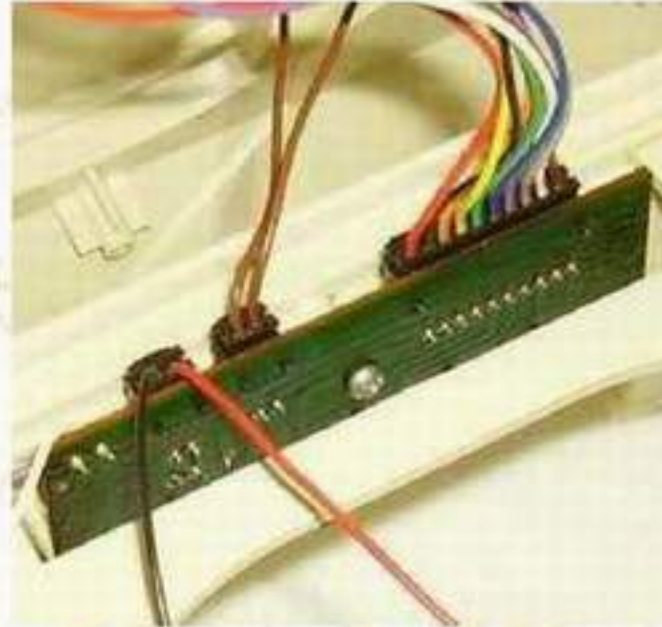
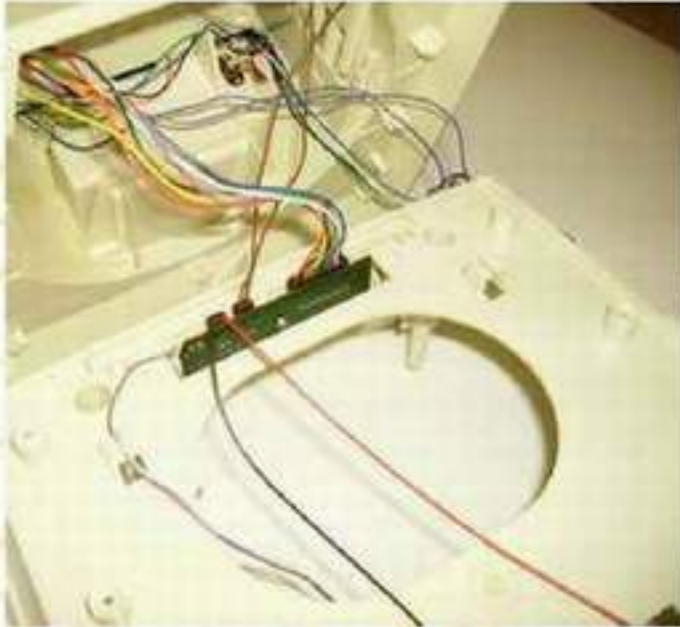

27. Install the wires and plugs that go to the external Jacks board on the base housing from the robot.

28. Install the base housing from the robot.



29. Install the screws from the base housing of the robot. Install the base housing to the robot, turn it and lay it flat on the table.



30. Turn the base and plug the three plugs from the drive box that go to the robot. Make sure that you place them properly.

The Old Robots Web Site

Omnibot[®]2000 - Arm Circuit Board



31. Join the bottom base to the housing and install the draw to the robot.



32. Turn the robot on to his back make sure that the head is free and not supporting the robot, then install the six screws from the bottom of the robot keeping the base and housing together.



33. Open the rear door and install the large 6 V 4 AH DC rechargeable battery, the two small AA battery's and the battery retainer and close the door.

There is no warranty expressed or implied with this procedure. By using any information from this web site, you agree not to hold responsible this site, me, nor any of its representatives, for any injuries and/or damages, both physical and/or psychological, that may arise from the use and/or misuse of anything derived from this site. The user further agrees that such information/pictures does not constitute any guarantee of accuracy, safety or reliability, and that cannot be held responsible for any way. The user agrees to proceed at their own risk.

The Old Robots Web Site

Omnibot[®]2000 - Arm Circuit Board



Relay Instruction Sheets

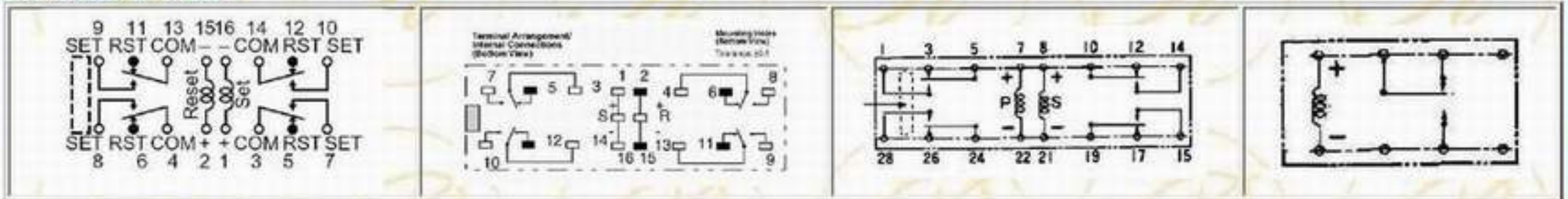

[Aromat Industrial Control Relay](#)

[Fujitsu VB-6TCU-E Relay](#)

[Omron PCB Relay](#)



[Click to Enlarge](#)



[Click to Enlarge](#)



[Click to Enlarge](#)

The Old Robots Web Site

Omnibot[®]2000 - Arm Circuit Board



[Click to Enlarge](#)



[Click to Enlarge](#)



[Click to Enlarge](#)



[Click to Enlarge](#)

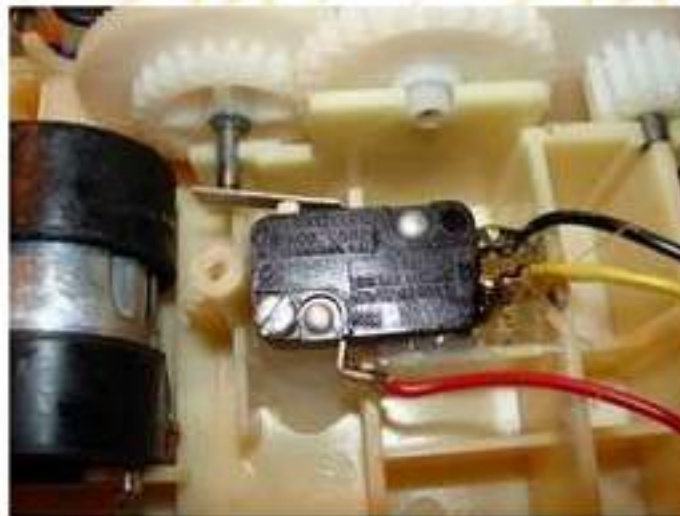

[Click to Enlarge](#)

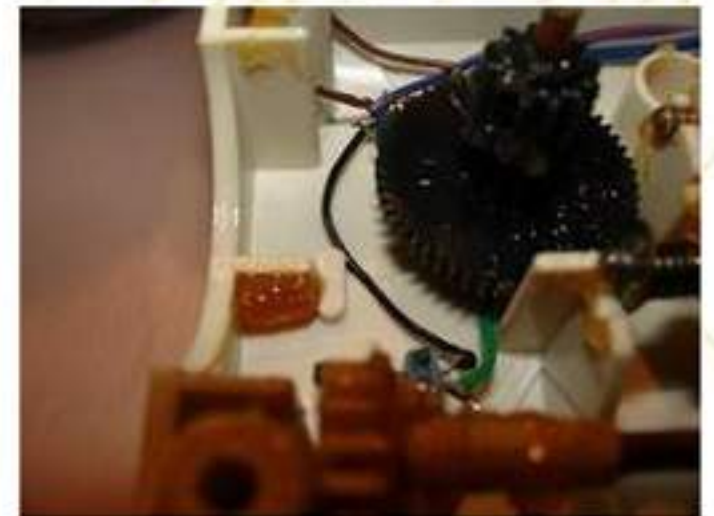

[Click to Enlarge](#)



[Click to Enlarge](#)



[Click to Enlarge](#)



[Click to Enlarge](#)



[Click to Enlarge](#)



[Click to Enlarge](#)



[Click to Enlarge](#)

There is no warranty expressed or implied with this procedure. By using any information from this web site, you agree not to hold responsible this site, me, nor any of its representatives, for any injuries and/or damages, both physical and/or psychological, that may arise from the use and/or misuse of anything derived from this site. The user further agrees that such information/pictures does not constitute any guarantee of accuracy, safety or reliability, and that cannot be held responsible for any way. The user agrees to proceed at their own risk.

The Old Robots Web Site

Omnibot[®]2000 - Arm Circuit Board

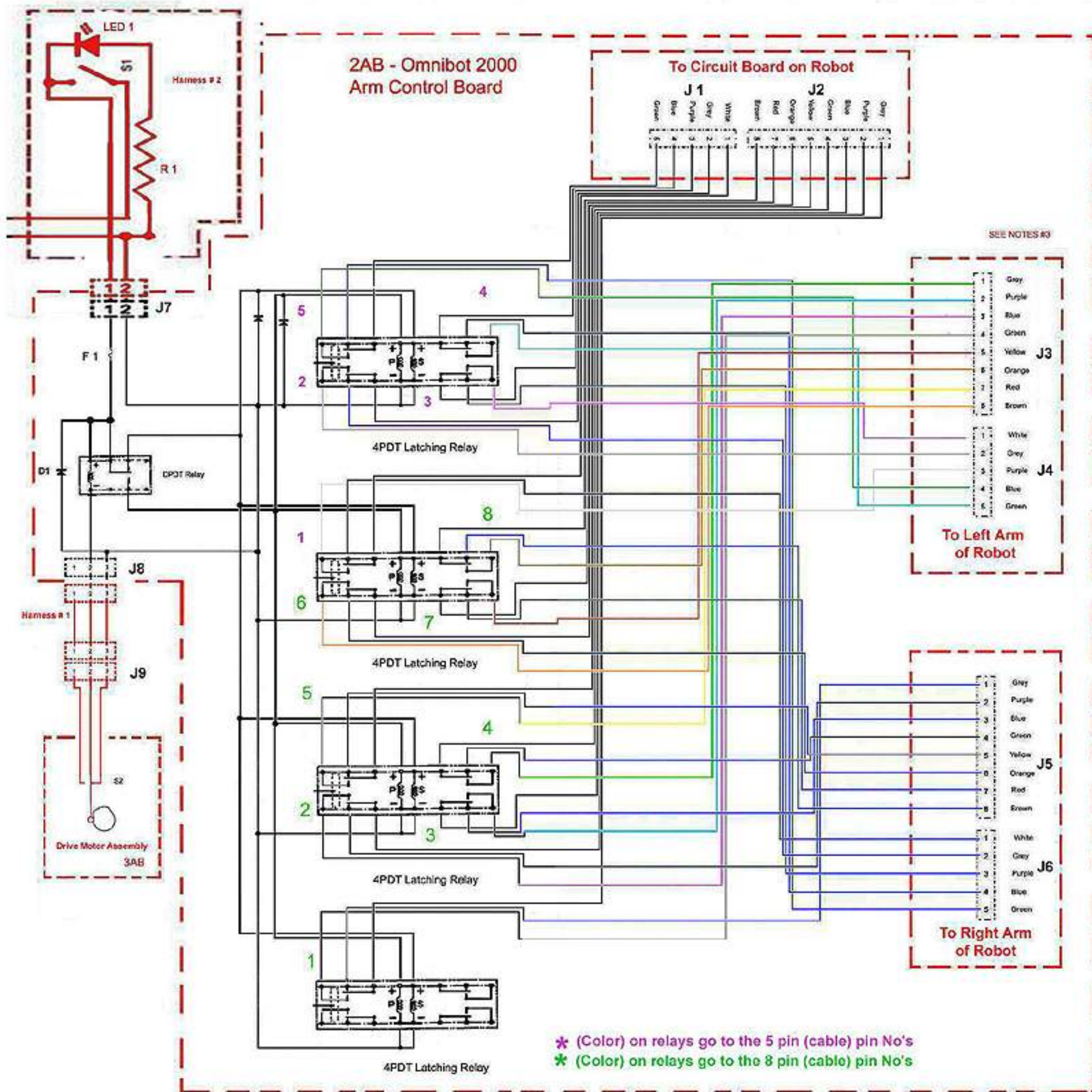

The Old Robots Web Site

Omnibot®2000 - Arm Circuit Board

ACKNOWLEDGEMENT AND APPRECIATION - I would like to extend Acknowledgement, Appreciation and Thanks, for Permission to use the Information and Pictures to, Friends, My Mentor, Individuals, The Hobbyist Collectors (World Wide), Robot Manufactures, Robot Collectables Stores, eBay Stores, Toy Museums, Web Sites, Book Authors and News Networks, that have helped me with recommendations, encouragement, support, information and pictures for the Users of this Book and Web Sites.

To Heath®, RB Robotics®, Androbot®, TTC®, Tomy® CBS Toys,® 2001 Trendmasters, Inc.®, Radio Shack®, Clone®, Ideal® Hasbro®, and All Other Companies That Manufacture The Robots, or Companies That Claim Ownership, of pictures and information that are presented in this book or on this site. This book or site represents a presentation of my collection of robots and is for hobbyist only, and not for commercial use. It is not intended to represent your company or implied prior approval of anyone or any company, and any pictures or information that is in conflict with your company or policies, will be revised or removed when requested. I would like you to consider that the pictures and information are of both a collector and historical interest to many people. Many times when such a collector comes into ownership of one of these robots it is incomplete, they rarely obtain all of the information and material that comes with it. Without this information, they have an incomplete item.

All images, names, information, quotes or sounds used are the property of respective owners. Copyright and trademarks have been acknowledged where possible. No affiliation or endorsement has been made or taken, unless clearly indicated. Infringement is not intended. Contents will be removed if in violation. All material posted is for identification, entertainment, information, demonstration purposes and historical documentation only.

RB Robotics® Still produces the RB5X®.

Androbot® Produced the Topo®, Fred® and BOB® robots Educational and Personal Robots.

CBS Toys Produced for IDEAL™ the Electronic Maxx Steele™ Personal Robot

All Other® Companies That Manufacture The Robots, or® Companies That Claim Ownership

Heathkit® Produced the Hero®, Hero Jr®, Hero 2000® and the Hero Arm Trainer®. Formerly from Heathkit, then Mobile Ed Productions, Now Proudly brought to you by the Robot Workshop!

Tomy Co Ltd. produced the Omnibot line of robots from 1982 up until 1988 TOMY Co., Ltd. - In Japanese, K.K. Takara-Tomy Founded March 1, 2006. Headquarters HQs in Japan, United States, United Kingdom, France, Hong Kong, Thailand. TOMY Co., Ltd. is the legal English name for the Japanese toy, children merchandise and Entertainment Company created on March 1, 2006 by the merger of "former" Tomy (Founded 1924) with Takara Co. Ltd. (Founded 1955). However, the new company made the unusual decision to adopt two different legal corporate names so while in English the name is simply TOMY, in Japanese the legal company name is the combined name, K.K. Takara-Tomy.

Tomy produced the largest robot line of the 80's. Tomy was very successful compared to other companies, and therefore many attempted to copy Tomy's robot image (decals, colours). Robots Produced not limited to, but include: Omnibot®, Omnibot® 2000, Hearoid® (TTC), Omni® Jr., Verbot®, Chatbot®, Crackbot®, Dustbot®, Hootbot®, Dingbot®, Flipbot®, Spotbot®

Radio Shack produced not limited to, but; include: Robie® Sr, Robie® Jr, Robie® The Talking Robot, Mobile Armatron®, Armatron®, Super Armatron®, and the Z-707 Iron Claw®

Axlon produced robots from 1984 up until 1986/7 Axlon produced a number of robots that include: Compurobot / George, Dogbot, Spybot, Talkabot. Compurobot was marketed as George in the UK by CGL but was Axlon design. The Axlon Company was founded by Nolan Bushnell (creator of Atari, Androbot Inc.) in 1984. Axlon was largely sold to Hasbro.

The pictures used are originals taken, manufactured or created from my robots, composite of pictures made by me, the manuals, instruction sheets, pictures or information sent to me, Advertisement and letters saved from the 1980,s, Magazines no longer printed, and pictures from the internet from other hobbyists.

The information contained in this book or on the site is not to be used for profit but you can copy it for personal use. You cannot claim ownership, restrict, or cause to be restricted, or change the status of any files that you download from this site. You cannot use the files for commercial use such as selling, advertising or monetary transactions. These files and pictures are free, you may use them, give them away, you cannot claim ownership restrict or sell them. When used, you must acknowledge from where the files originated.

Omnibot

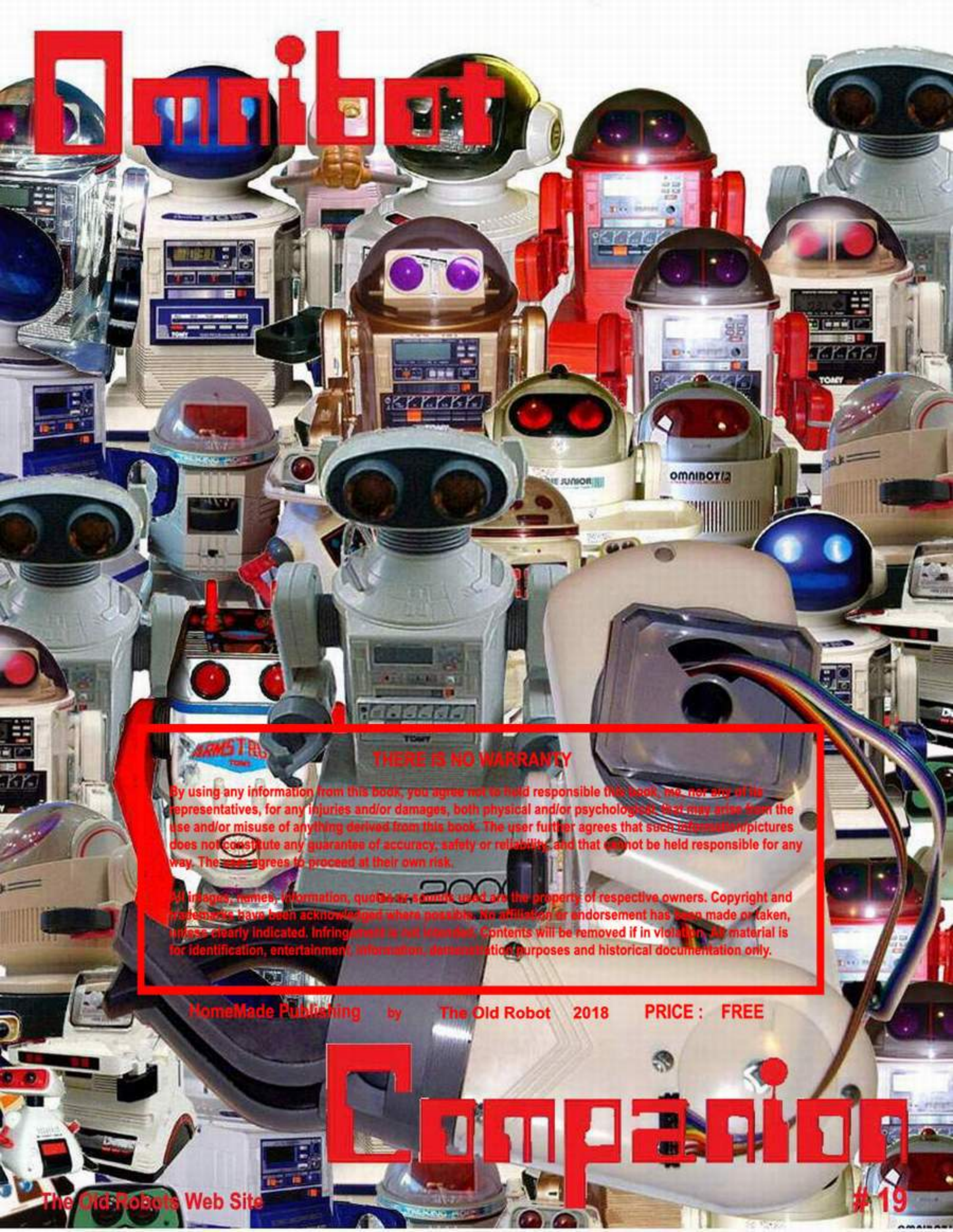

THERE IS NO WARRANTY

By using any information from this book, you agree not to hold responsible this book, me, nor any of its representatives, for any injuries and/or damages, both physical and/or psychological, that may arise from the use and/or misuse of anything derived from this book. The user further agrees that such information/pictures does not constitute any guarantee of accuracy, safety or reliability, and that cannot be held responsible for any way. The user agrees to proceed at their own risk.

All images, names, information, quotes or sounds used are the property of respective owners. Copyright and trademarks have been acknowledged where possible. No affiliation or endorsement has been made or taken, unless clearly indicated. Infringement is not intended. Contents will be removed if in violation. All material is for identification, entertainment, information, demonstration purposes and historical documentation only.

HomeMade Publishing by The Old Robot 2018 PRICE : FREE

Companion